

Product Brochure For A3616

Hyper Elevated Workshop Stool - DHRS-760

400 x 300mm Padded Seat & 240 x 150mm Backrest
180kg Load Capacity

On Sale

Ex GST

Inc GST

~~\$388.00~~

~~\$446.20~~

\$300.00

\$345.00



ORDER CODE:	A3616
MODEL:	DHRS-760
Seat Type:	Elevated Workshop Stool
Padded Seat Size (mm):	400 x 300mm
Seat Height (mm):	660 - 760mm
Work Tray (mm):	-
Load Capacity (kg):	~
Nett Weight (kg):	11.5



Description

The HAFCO Hyper Elevated Workshop Stool is built tough for the workshop, providing comfort and stability at bench height. With a heavy-duty cast aluminium frame, ergonomic seating, and smooth height adjustment, this stool is designed for serious use in fabrication shops, garages and industrial environments. Durable, practical and comfortable, it's the ideal companion for long days at the bench.

Features

- Adjustable height (Seat height = 660 – 760 mm)
- Gas-lift mechanism for quick and easy seat height adjustment to suit taller benches and standing workstations.
- Heavy-duty cast aluminium construction
- Strong cast frame rated to 180 kg load capacity for long service life in demanding conditions.
- 360° swivel seat
- Rotate freely without strain when moving between tools or work areas.
- Stable 5-leg base
- Wide footprint lowers the centre of gravity, reducing the risk of tipping in busy workshop environments.
- Large 100 mm castors
- Oversized wheels roll smoothly over workshop floors, cables and debris for added mobility.
- Ergonomic design
- Padded seat cushion, features 70 mm thick high density foam, with backrest support reduces fatigue during extended use.
- Powder-coated finish
- Durable surface resists scratches and workshop wear while remaining easy to clean.
- Locking castors & backrest guard included
- Added safety and protection as standard.

Product Brochure For A3616

Why You Need A Hyper Elevated Workshop Stool!



Save Your Knees & Back

Working low to the ground puts all the strain in the wrong places. The elevated height takes pressure off your joints so you can stay comfortable longer.

Move Around Safely

The large 100mm wheels glide easily over cords and rough floors, while the five-leg base keeps the stool stable and balanced, even when leaning or reaching. It moves when you need it and stays planted when you don't.



Comfort Levels: Up. Productivity: Also Up.

The 70mm foam seat and ergonomic design offer superior support for long jobs. The 360° swivel prevents back strain when reaching, and the gas-lift adjustment easily sets the perfect height for any workstation.

Tough Enough For Your Worst Day

Built for reliability, the heavy-duty cast aluminum frame is rated to 180kg, easily handling demanding workshop conditions. The powder-coated finish resists scratches and wear, ensuring long-term durability and easy cleaning.



Specs & Dimensions

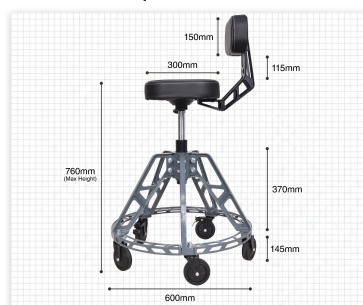

Padded Seat Size
400 x 300mm

Load Capacity
180kg

Castor Size
100mm

Adjustable Height
660-760mm

Unsure About Hyper Elevated Workshop Stool?

Give our specialists a bell, and they'll be able to sort you out with the perfect product for your needs.

Call (02) 9880 9111

Product Brochure For A3616

Specific Features



Seat



Perfect For Resto Jobs



Frame

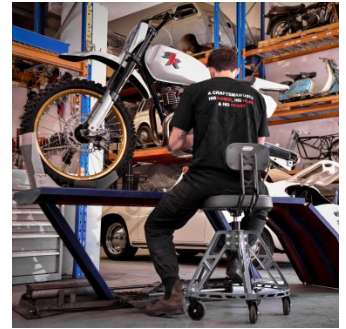

Ideal For Motorcycle Work



Back Rest



Sit Down Weld All Day



Maximum 760mm Height



Minimum 660mm Height



Seat Lever