

Product Brochure For C409

Industrial Caster Wheels - CW-102S

Ø100mm Wheels
2 x Swivel/Brake



On Sale

Ex GST

~~\$86.00~~

\$68.70

Inc GST

~~\$98.90~~

\$79.00

ORDER CODE:	C409
MODEL:	CW-102S
Quantity of Wheels in Pack (No.):	2
Wheel Type:	2 Swivel/Brake
Wheel Diameter (mm):	Ø100
Wheel Width (mm):	50
Total Height to Top of Plate (mm):	145
Load Capacity per Wheel (kg):	400
Load Capacity per Set (kg):	
Nett Weight (kg):	6



Description

Industrial quality Ø100mm caster wheels, Tyre is made from 7mm thick polyurethane with an load capacity of up to 400kg per caster.

Features

- Ø100mm x 50mm wide polyurethane wheel
- 2 x swivel wheels with brake
- 400kg each wheel capacity
- Brake also locks wheel from swivelling
- Swivel base incorporates ball bearings
- Ball bearing sealed race on main shaft
- 145mm overall height from base of wheel to top of plate
- Mounting plate 114.5 x 101.5mm with 4 slotted holes

Product Brochure For C409

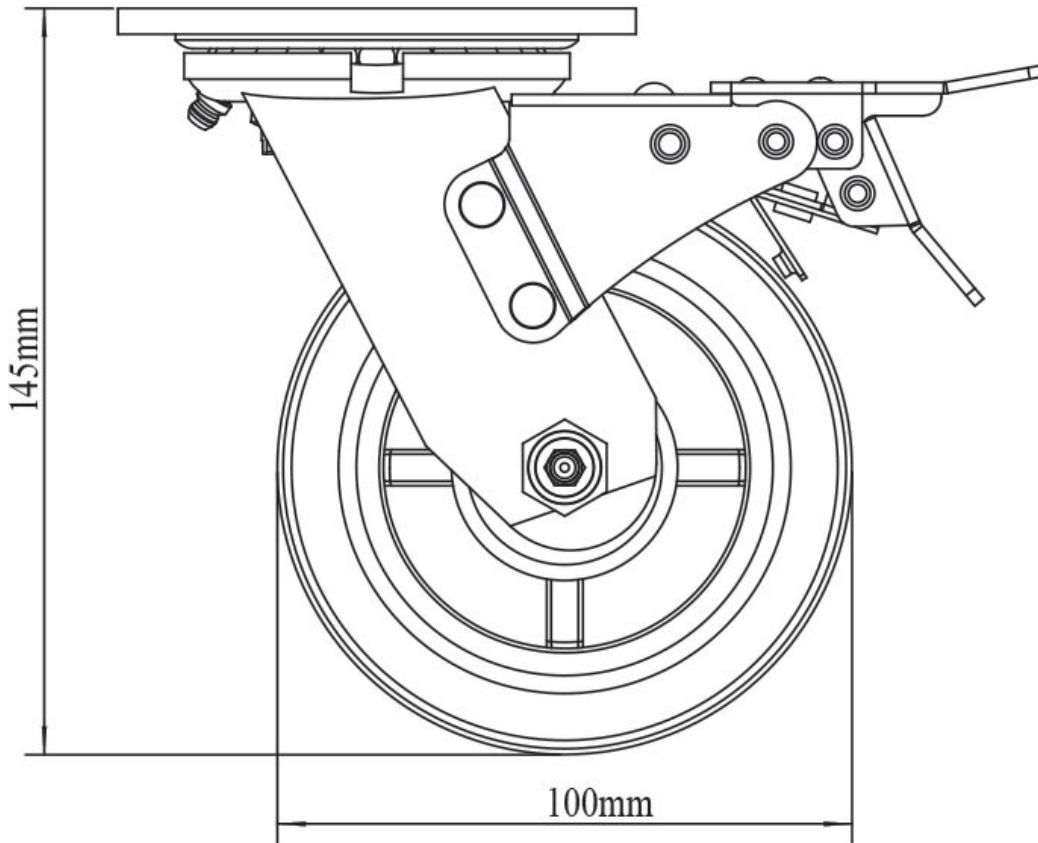

Specific Features



Foot Brake



Top View



Ball Bearing Base With Greasing Nipple

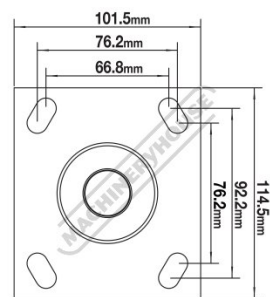

Baseplate dimensions

Baseplate Dimensions

Product Brochure For C409

Recommended Accessories

W08453
750 x 1000mm 1D Welding
Table



W08455
Welding Table



A380
Steel Work Bench - 3 x Lockable
Drawers



A415
Industrial Work Bench



A420
Industrial Work Bench



F298
Stainless Steel Bench with
Splashback



F280
Stainless Steel Island Work
Bench



S014
Industrial Steel Shelving

