

Product Brochure For D5220

470mm Sino Digital Readout Scale - MK-300-470/5U

Standard Scale
5µm Resolution



ORDER CODE:	D5220
MODEL:	~
Type:	Standard Scale
Travel - Maximum (mm):	470
Overall Length (L) (mm):	~
Scale Resolution (µm):	5
Grating Pitch:	~
Accuracy (µm):	~
Output Signal:	~
Connector:	~
Cable Length (Metre):	3
Working Temperature (°C):	~
Sealing Protection Class:	~
Maximum Speed (M/min):	~
Reference Point:	~
Width x Height (W x H) (mm):	~
Backing Support Plate (Yes / No):	No

SINO



Description

Sino MK series DRO scales offer an affordable low cost solution for your Lathe or Milling machine digital readout requirements. Scales lengths available in a range from 170mm to 1020mm. Compact scales available ranging from 170mm to 270mm specially designed to suit X-Axis travels on Lathes.

Features

- Scale body made from extruded aluminium with wiper seals
- Glass scale with 5µm resolution
- 3m connection cable with 9 pin D-Sub connector
- The slide carrier of the MK series scales uses Japanese NSK bearings to provide high precision, low noise and long service life
- Includes cover & mounting screws
- Optional mounting backing plates available for ease of installation on non-machined surfaces
- An easy-to-follow D.I.Y. Installation Manual is supplied with each system, complete with illustrations and mounting brackets

Optional Accessories

- Mounting backing plate to suit (D5240) available for ease of installation on non-machined surfaces

Sino MK-300 Series Scales

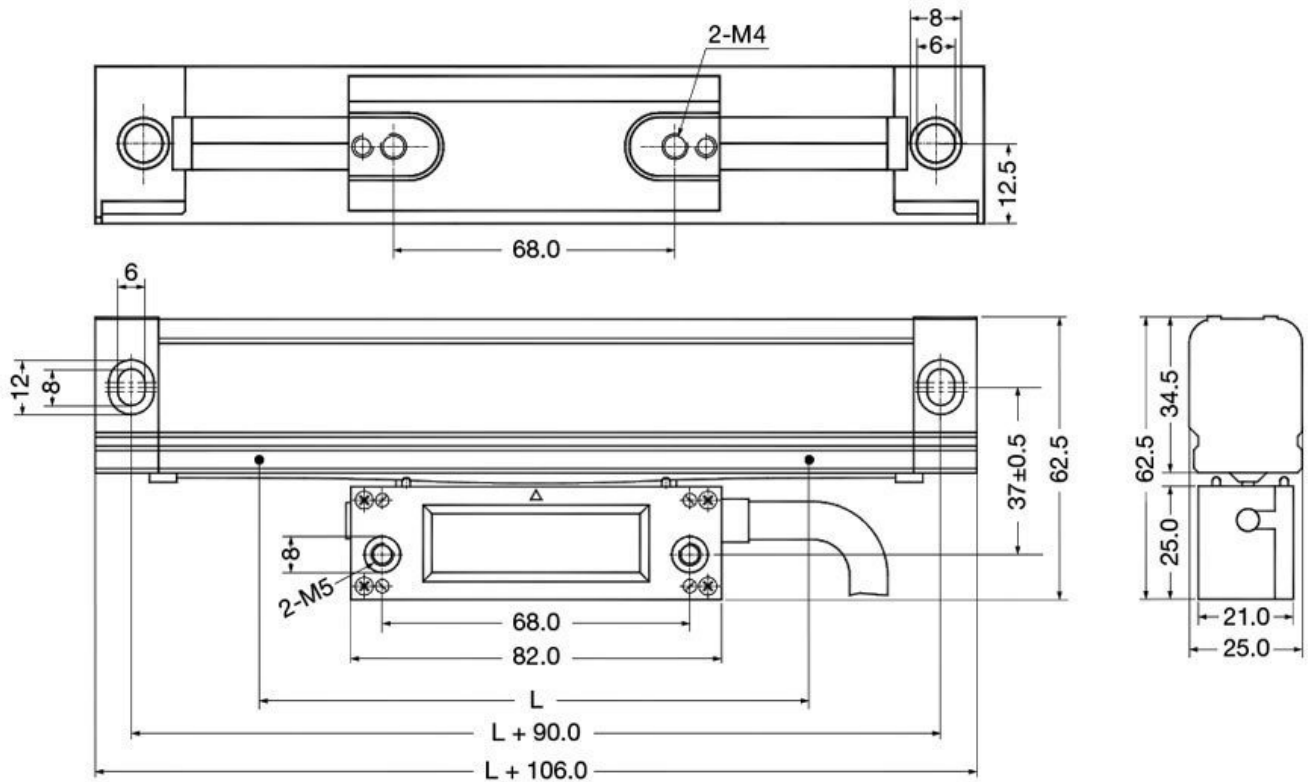

L = Effective measuring length of scale

Product Brochure For D5220

Specific Features



Reader Head



DSub9 Male Plug



Included Parts

Recommended Accessories

D5240

Scale - Backing Plate & Cover

