

Product Brochure For D8165

HSS Jobber Drill Pack - 5 Piece - Ø8.5mm

M35 Grade HSS with 5% Cobalt
135° Precision Ground Flute & Split Point

On Sale

Ex GST	Inc GST
\$28.00	\$32.20
\$21.74	\$25.00



ORDER CODE:	D8165
Drill Size (DS) (mm):	8.5
Flute Length (FL) (mm):	75
Drill Length (DL) (mm):	117
Quantity Per Pack (No.):	5
Point Angle (Degrees):	135°
Standard (DIN):	DIN 338



Description

Alcock Drill Bits are manufactured to DIN 338 standards from M35 HSS with 5% cobalt for outstanding durability, heat resistance, and drilling performance. Precision-ground flutes ensure fast chip removal, while the 135° split-point tip cuts quickly, self-centres, and reduces wandering—perfect for tougher steels. Finished in a durable bronze coating.

Supplied in handy packs so you'll always have the right size ready—ideal for any workshop.

Sizes: 1.0–13.0mm (0.5mm steps)
Packs: 10pcs (1.0–7.5mm), 5pcs (8.0–13.0mm)

Features

- M35 Grade HSS including 5% Cobalt
- Designed for high durability & heat resistance
- Precision ground flutes for fast chips removal
- 135° cuts faster & split point tip reduces wandering
- Manufactured to DIN 338 Standard
- Bronze oxide finish to reduce friction

Product Brochure For D8165

JOBBER DRILL PACKS

- M35 Grade HSS with 5% Cobalt
- Designed for high durability & heat resistance
- Precision ground flutes for fast chips removal
- 135° cuts faster & split point tip reduces wandering



HSS
M35 GRADE

5%
COBALT

DIN
338

10 PIECE
PACKS
1~7.5mm

5 PIECE
PACKS
8~13mm

135°

SPLIT POINT

HIGH HEAT RESISTANCE

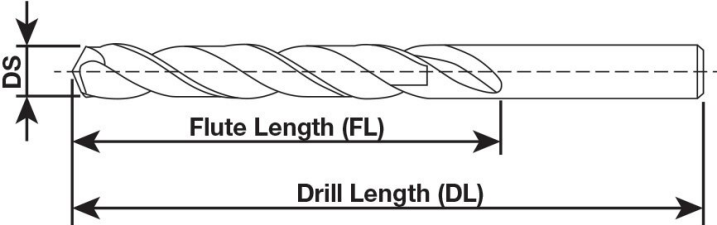

ORDER CODE:	DRILL SIZE (DS)	PIECES per size	FLUTE LENGTH (FL)	DRILL LENGTH (DL)
D8150	1.0mm	10pcs	12	34
D8151	1.5mm	10pcs	20	43
D8152	2.0mm	10pcs	24	49
D8153	2.5mm	10pcs	30	57
D8154	3.0mm	10pcs	33	61
D8155	3.5mm	10pcs	39	70
D8156	4.0mm	10pcs	43	75
D8157	4.5mm	10pcs	47	80
D8158	5.0mm	10pcs	52	86
D8159	5.5mm	10pcs	57	93
D8160	6.0mm	10pcs	57	93
D8161	6.5mm	10pcs	63	101
D8162	7.0mm	10pcs	69	109
D8163	7.5mm	10pcs	69	109
D8164	8.0mm	5pcs	75	117
D8165	8.5mm	5pcs	75	117
D8166	9.0mm	5pcs	81	125
D8167	9.5mm	5pcs	81	125
D8168	10.0mm	5pcs	87	133
D8169	10.5mm	5pcs	87	133
D8170	11.0mm	5pcs	94	142
D8171	11.5mm	5pcs	94	142
D8172	12.0mm	5pcs	101	151
D8173	12.5mm	5pcs	101	151
D8174	13.0mm	5pcs	101	151

Product Brochure For D8165

Specific Features



135° Split Point - M35 Grade HSS 5% Cobalt

JOBBER DRILL PACKS 

- M35 Grade HSS with 5% Cobalt
- Designed for high durability & heat resistance
- Precision ground flutes for fast chips removal
- 135° cuts faster & split point tip reduces wandering

HSS M35 GRADE	5% COBALT	DIN 338	10 PIECE PACKS	5 PIECE PACKS
135°	SPLIT POINT	HEAT RESISTANCE	1-7.5mm	8-13mm

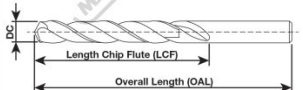

Jobber Drill Packs

Recommended Accessories

D126

Metric 135° Precision HSS Drill Set - 170 Pieces



D1272

Metric 135° Precision HSS Drill Set - 25 Piece



D1282

Imperial 135° Precision HSS Drill Set - 29 Piece



D1285

Metric 135° Precision HSS Drill Set - 51 Piece

