

Product Brochure For G612

Lathe Safety Chuck Guard - LG-8

203mm Centre Height



On Sale

Ex GST	Inc GST
\$244.00	\$280.60
\$193.91	\$223.00

ORDER CODE:	G612
MODEL:	LG-8
Guard Type:	Safety Chuck Guard
Material Type:	Steel
Leadscrew Cover Width (mm):	~
Suits Lathe - Distance Between Centres (mm):	~
Suits Lathe Centre Height (mm):	203
Suits Lathe Chuck Size Max. (mm):	Ø250



Features

- Retro fits to lathe headstock with a 203mm centre height
- Suits up to Ø250mm lathe chucks
- Swivel steel safety chuck guard with handle
- Includes safety chuck guard, mounting bracket with micro switch and wiring
- Micro switch recommended for 12V or 24V
- Installation required by a licensed electrician

Product Brochure For G612

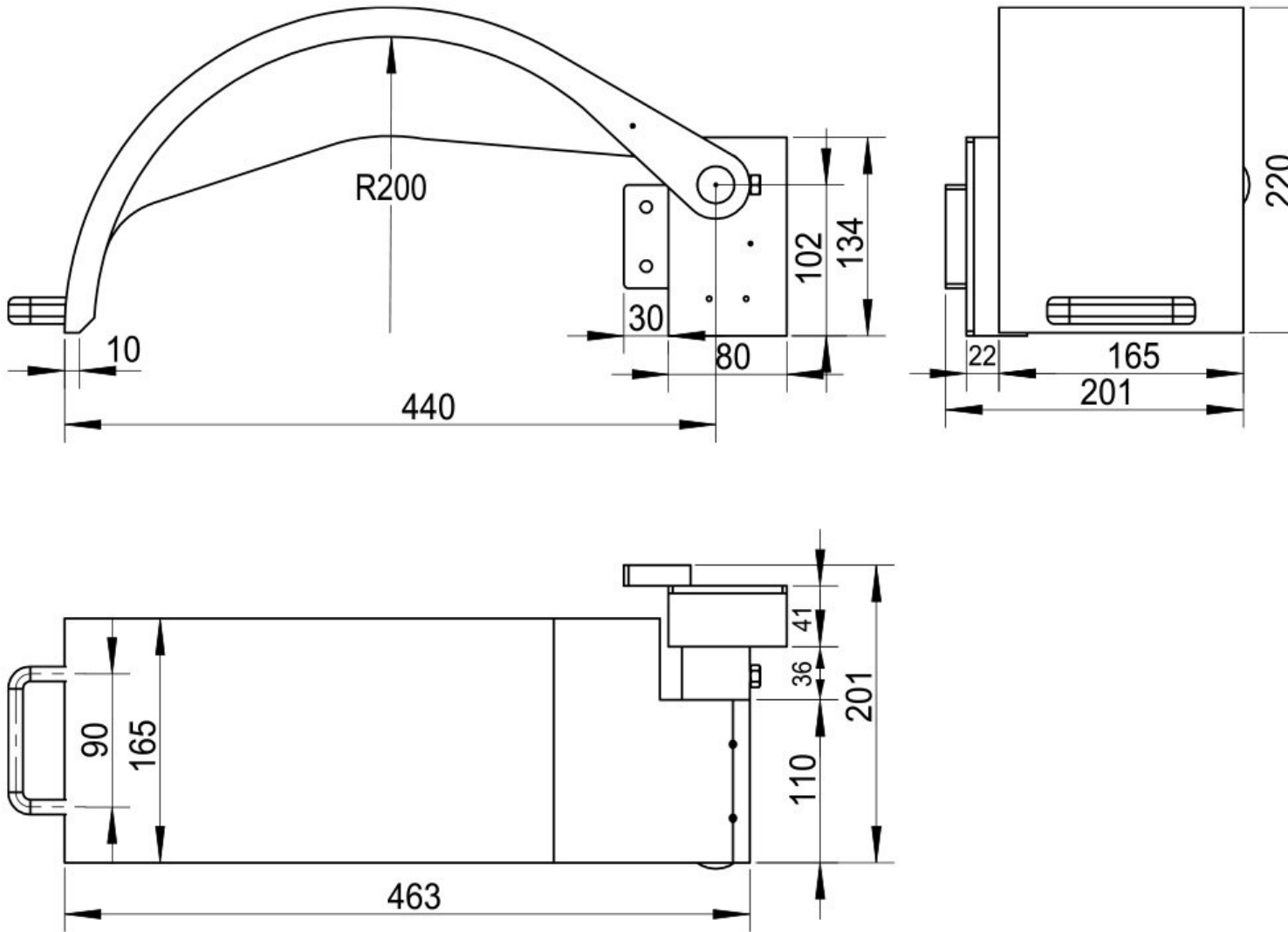

Product Brochure For G612

Specific Features

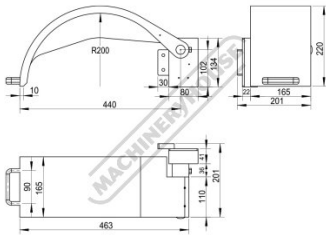

Dimensions