

Product Brochure For H259

Compact Wire Rope Hoist - TBH500

500kg Lifting Capacity
30 Metre Lifting Height



On Sale

Ex GST	Inc GST
\$1,500.00	\$1,725.00
\$1,400.00	\$1,610.00

ORDER CODE:	H259
Model:	TBH500
Brand:	TOHO
Lifting Capacity (kg):	500
Lifting Height (Metre):	30
Speed (m/min):	13
Pendant Control Length (Metre):	10
Wire Rope Diameter (mm):	6
Motor Output (kW):	1.6
Voltage (V):	240
Nett Weight (kg):	30



Description

Designed for use on building sites and multi-storey units, these compact electric rope hoists are also suitable for a wide range of applications in warehouses, storage areas, factories, etc.

Features

- Light weight and compact design allowing for easy installation
- Automatic upper limit switch, when rope disc touches the limit arm, hoisting is automatically stopped
- Lower overwind limit switch
- Dynamic and mechanical brake providing instant and safe braking
- Convenient 240 volt/single phase power supply
- Sensor arm automatically stops motor if the wire rope is under-wound
- Wire rope with 360° weighted hook with safety latch
- Supplied with 3 metre power lead and industry plug & 10 metre heavy duty IP65 waterproof pendant control
- Complies with AS/NZS 1418.2 standard

Product Brochure For H259

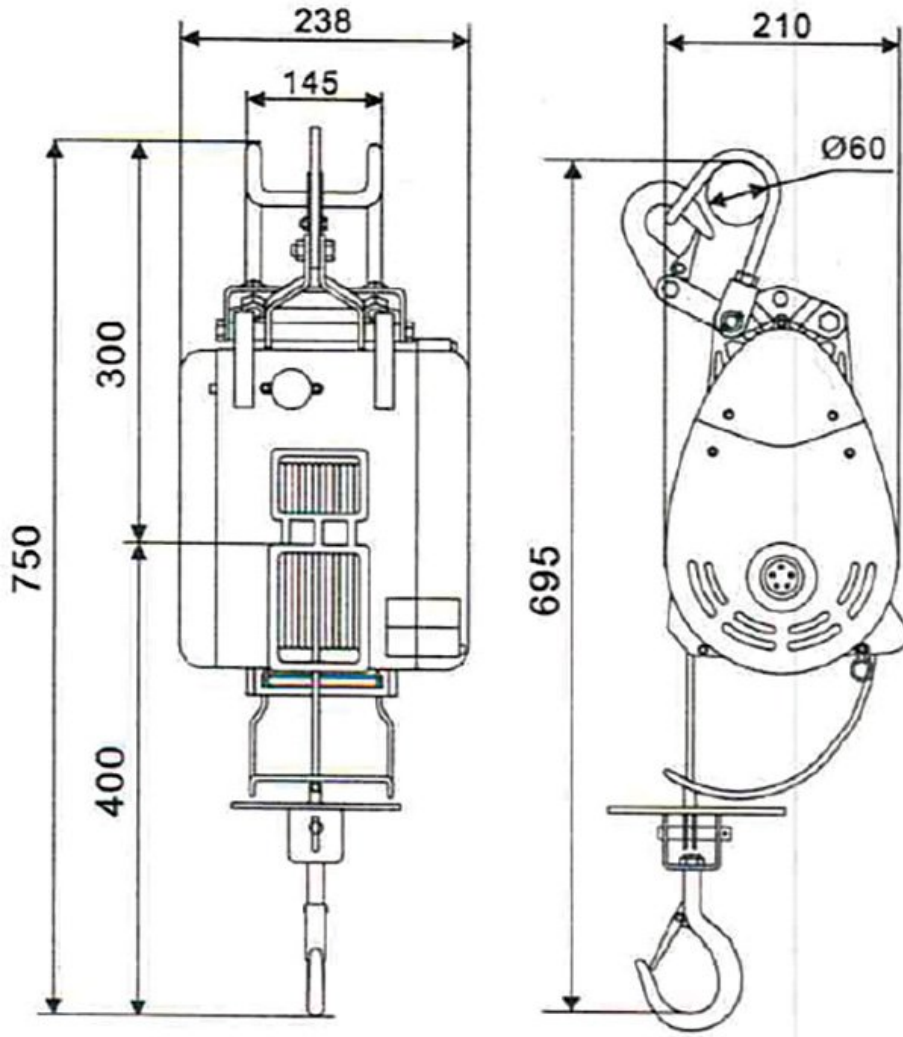

Product Brochure For H259

Recommended Accessories

H259A
Wireless remote t/s builders hoist



C147
Girder Trolley



H300
Round Slings



H316
Flat Slings



H305
Round Slings



H318
Flat Slings



H308
Round Slings



H307
Round Slings



Product Brochure For H259

H320
Flat Sling



H310
Round Sling



H314
Round Sling



H322
Flat Sling



H312
Round Sling



H324
Flat Sling

