

Product Brochure For K0012

Opti-Turn Bench Lathe Package Deal - TU-3008G

Ø300 x 700mm Turning Capacity - Ø38mm Spindle Bore
12 Geared Head Speeds 125 ~ 2400rpm & Includes Stand & Turning Kit



OPTIMUM



On Sale - Package Deal

Ex GST	Inc GST
\$5,004.00	\$5,754.60
\$4,480.00	\$5,152.00

Package Contents - SAVE \$1,179.90 (Inc)

1 x L691 - Opti-Turn Bench Lathe TU-3008G	\$5,262.40
1 x L690 - Lathe Stand ST-2506V	\$561.20
1 x L0077 - Lathe Turning Tool Kit - 7 piece Insert Type	\$253.00
1 x C290 - Heavy Duty Drill Chuck - Keyed Type	\$112.70
1 x D443A - 3MT x JT3 Drill Chuck Arbor	\$29.90
1 x C052 - 3MT Live Centre	\$112.70
Normal Price (Inc):	\$6,331.90

ORDER CODE:	K0012
MODEL:	TU-3008G - Package Deal
Swing Over Bed (mm):	300
Distance Between Centres (mm):	700
Spindle Bore (mm):	38
Swing In Gap (mm):	~
Swing Over Cross-slide (mm):	190
Digital Readout System Fitted:	Optional
Quick Change Toolpost Fitted:	Optional
Leadscrew Covers Fitted:	~
Taper Turning Attachment:	~
Coolant System:	~
Tool Height To Suit (mm):	16
Centre Height (mm):	150
Spindle Nose Size or Type:	D1-4
Bed Width (mm):	180
Headstock Spindle Taper (MT):	5
Tailstock Taper (MT):	3
Cross Slide Travel (mm):	150
Compound Slide Travel (mm):	65
Leadscrew Type:	Metric
Metric Cross Feed (X-Axis) (mm/rev):	0.01 ~0.10
Imperial Cross Feed (X-Axis) (inch/rev):	~
Metric Longitudinal Feed (Z-Axis) (mm/rev):	0.085 - 0.83
Imperial Longitudinal Feed (Z-Axis) (inch/rev):	~
Metric Thread Steps & Pitch (No. / mm):	18 (0.2 - 3.5)
Imperial Thread Steps & TPI (No. / TPI):	21 (8 - 56")
3 Jaw Chuck Diameter (mm):	160
4 Jaw Chuck Diameter (mm):	Optional
Spindle Steps / Speeds (No. / rpm):	12 (125 - 2400)
Motor Power (kW / hp):	1.5 / 2
Voltage / Amperage (V / amp):	240 / 10
Nett Weight (kg):	365

Description

This new TU-3008G model geared head lathe of very modern design has many convenient facilities ideal for the enthusiastic model engineer for small component manufacturer. A very rigid 180mm cast iron bed width, induction hardened and ground slideways gives a high level of precision turning. The lathe capacity is 700mm between the centres and 300mm swing over the bed and with a generous 38mm spindle bore

Product Brochure For K0012

allowing larger stock to be placed through the headstock. The workhorse that drives this lathe has an upgraded powerful 2hp (1.5kW) motor providing smooth running.

Other very useful features included are cross and longitudinal power feeds that's not normally found of small conventional lathes, quick lock tailstock and both metric and imperial thread cutting, ranging from 8-56 tpi or 0.2-3.5mm pitch. Also included are a 4-way indexing tool post with 16mm tool shank capacity, fine adjustment on the tailstock for taper turning and the rear splash guard. A 160mm 3-jaw chuck with reverse jaws is also supplied. There are many additional options available including a milling head (BF-16AV) or (BF-20AV) to turn this machine into a very capable all round machining centre.

Features

- Geared headstock for quick change of 12 spindle speeds 125-2400rpm
- Ribbed prism bed made of grey cast iron
- Inductively hardened and ground bed guideways
- Automatic cross & longitudinal power feeds
- Spindle nose accuracy 0.009mm
- 3 Jaw chuck running accuracy 0.04mm
- D1-4 camlock spindle for quick chuck changes
- Forward & reverse spindle direction switch
- Oils sight glass on head-stock & gearbox
- Change gears for metric and imperial thread cutting
- Enclosed feed and threading gearbox
- Belt cover with tamper proof safety micro switch
- Heavy duty rotating safety chuck guard with micro switch
- Sliding tool post safety guard
- Cross slide & bed length are designed to fit Optimum DRO scales

Includes

- TU-3008G - Opti-Turn Bench Lathe (L691)
- ST-2506V Lathe Stand (L690)
- 7 piece - Lathe Turning Tool Kit - Insert Type (L0077)
- Heavy Duty - Drill Chuck - Keyed Type (C290)
- 3MT x JT3 - Drill Chuck Arbor (D443A)
- 3MT Live Centre (C052)
- Change gears for metric & Imperial thread cutting
- Chuck guard
- Toolpost guard
- 2 dead centres
- 3-jaw chuck with reversible jaws
- Swarf drip tray
- Rear splash guard

Optional Accessories

- 200mm 4 jaw independent chuck - C252
- Travelling steady - L6917
- Fixed steady - L6916

Specific Features



Right Front View



Front View



Shown with Optional Stand L690 Top View



Shown with Optional Stand L690 Left View

Product Brochure For K0012



Safety Chuck Guard



Safety Chuck Guard Open Position



Headstock Controls



Spindle Speed Levers and Speed Chart



Headstock Controls

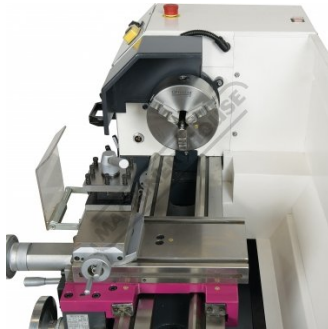

Top View Saddle and Chuck



Spindle Direction and Emergency Stop Switches



On Off Switch



38mm Through Spindle Bore

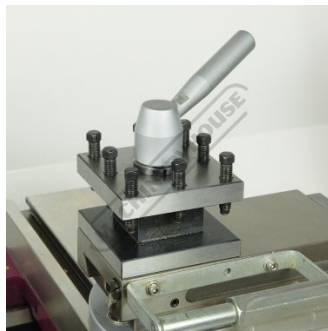

4 Way Toolpost

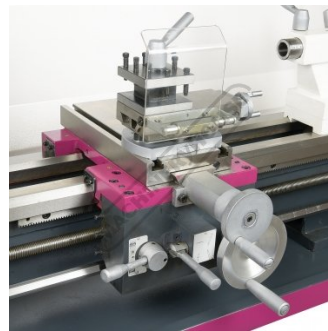

Saddle Left View

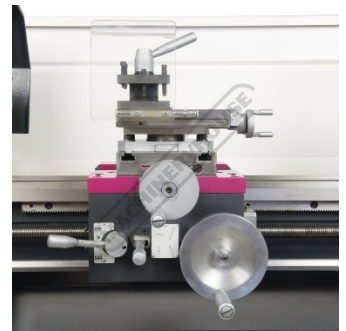

Saddle Front View

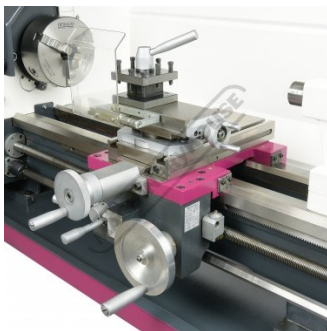

Saddle Right View

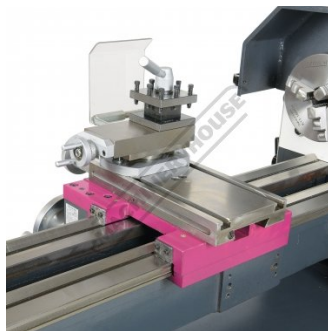

Saddle Rear View

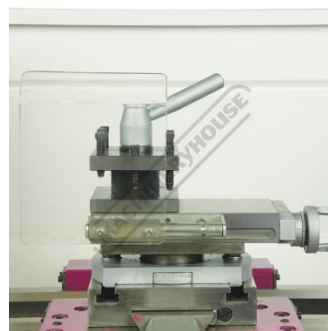

Safety Cutter Guard Left

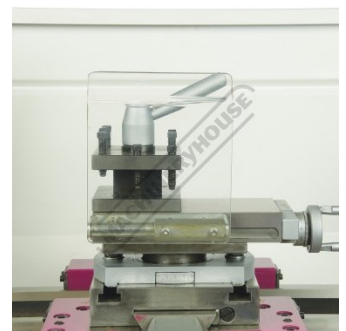

Safety Cutter Guard Right

Product Brochure For K0012

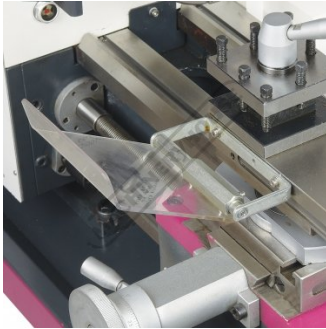

Safety Cutter Guard Tilted Down

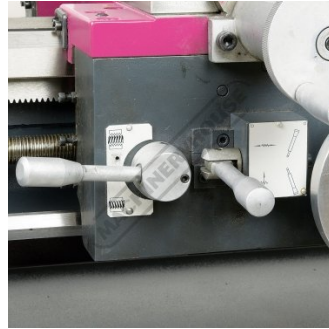

Feed and Thread Engagement Levers

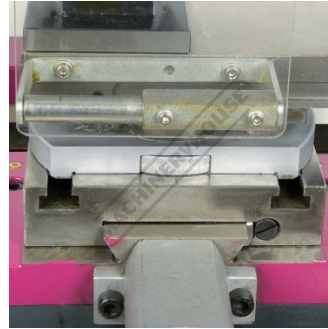

Swivel Compound Slide

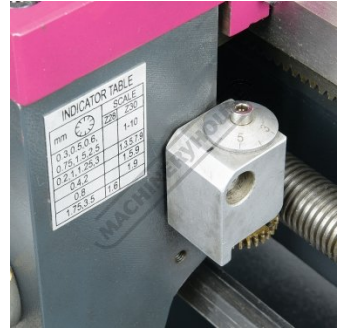

Product Brochure For K0012

Recommended Accessories

K149
Opti-Turn Lathe & Mill Drill
Combination Package Deal



L690
Lathe Stand



C252
4 Jaw Independent Lathe Chuck



L6917
Lathe Steady - Travelling



L6916
Lathe Steady - Fixed



M647
Opti-Mill Head Attachment -
Geared & Tilting Head



D695
3-Axis Optimum Digital Readout
Counter - 1µm



D694
1500mm Optimum Magnetic
Digital Readout Scale



Product Brochure For K0012

P235
Coolant Pump & Tank



L017
Right Hand Turning Tool Holder



L018
Left Hand Turning Tool Holder



L0077
Lathe Turning Tool Kit - 7 piece
Insert Type



L451
Lathe Turning Tool Kit - 3 piece
Insert Type



L457
Lathe Threading Tool Kit - Insert
Type



L465
Professional Lathe Parting Tool
Kit - Insert Type



C052
3MT Live Centre



C290
Heavy Duty Drill Chuck - Keyed
Type



D443A
3MT x JT3 Drill Chuck Arbor



D1272
Metric 135° Precision HSS Drill
Set - 25 Piece



D1282
Imperial 135° Precision HSS
Drill Set - 29 Piece



Product Brochure For K0012

D126
Metric 135° Precision HSS Drill Set - 170 Pieces



S090A
Soluble Metal Cutting Fluid - 1 Litre



S090
Soluble Metal Cutting Fluid - 5 Litre



S076
Cutting Tool Lubricant Fluid - 500ml



S077
Drilling, Tapping & Cutting Tool Lubricant Spray - 400g



S074
Cutting Tool Lubricant Paste - 500g



L341
Fitting and Machining Technical Book

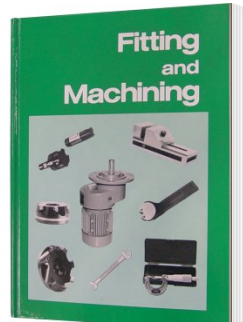

L345
Handy Workshop Tips & Techniques - 1st Edition



L3455
Professional Sheet Metal Fabrication Book

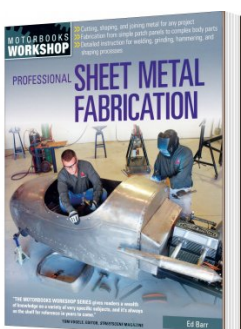

L300
Magnetic Swarf Remover



M9991
Magnetic Floor Sweeper



M800
Rubber Mat - Anti-Fatigue



Product Brochure For K0012

M805
Rubber Mat - Anti-Fatigue

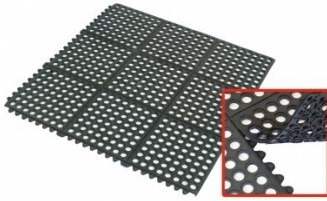

O043
Rust & Corrosion Preventive



O042
General Purpose Lubricant & Corrosion Inhibitor



O044
Rust & Corrosion Preventive

