

Product Brochure For L039

Right Hand Turning Tool Holder - MWLNR-2020-K08W

20mm Tool Height

Insert tip not included

On Sale

Ex GST

~~\$98.00~~

\$76.52

Inc GST

~~\$112.70~~

\$88.00



ORDER CODE:	L039
Part Number - Style:	MWLN
Tool Height Size (mm):	20
Clamping Method of Insert:	~
Category:	~
Connection style:	~
Back End Size:	~
Application:	~
Hand Type:	Right
Holder Style:	~
Clearance Angle:	~
Insert Type:	WNMG08
A (H) (mm):	20
B (mm):	20
C (LF) (mm):	125
LH (mm):	~
F (WF) (mm):	25
E (mm):	~



Description

NOTE: Inserts not included with tool holders

Use insert WNMG 080408 (L053)

Features

- Negative rake turning tool holder suitable for turning and facing
- Suitable for rapid metal removal

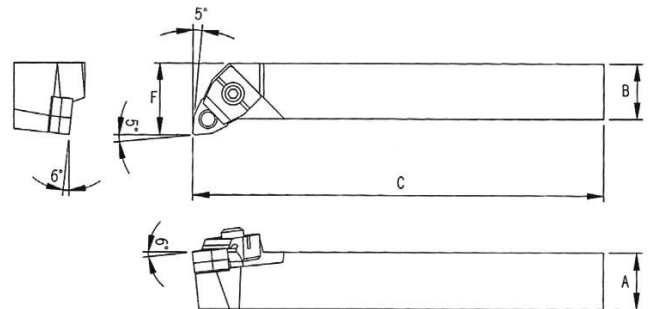

Product Brochure For L039

SETTING THE SPINDLE SPEED

To calculate the correct speed the following metric formula can be used

$$RPM = \frac{1000 \times \text{Surface speed in Metres per Minute}}{3.14 \times \text{Diameter in millimetres}}$$

Material	Approximate surface speeds for carbide tools	
	Roughing	Finishing
Mild Steel	50	80
Cast Iron	40	60
Aluminium	80	100
Stainless Steel	40	50

Example 1.

20mm Mild Steel bar to be rough machined

$$RPM = \frac{1000 \times 50}{3.14 \times 20mm} = \frac{50000}{62.8} = 796rpm$$

Example 2.

20mm Mild Steel bar to be finished machined

$$RPM = \frac{1000 \times 80}{3.14 \times 20mm} = \frac{80000}{62.8} = 1273rpm$$

- Set the spindle speed to the closest speed to the RPM calculated
- If in doubt then set a speed slower than the calculated speed

SETTING THE TOOL ON CENTRE

For the tool to cut correctly it needs to be set on centre. This can be best achieved by placing a centre in the tailstock and packing the tool until the tool is on centre.

Correct centre height



Incorrect centre height



Specific Features



Close Up



Shown with insert sold separately

Product Brochure For L039

Recommended Accessories

L053
KYOCERA Carbide Inserts -
Turning

L0534
KYOCERA Carbide Inserts -
Turning

L0538
KYOCERA Carbide Inserts -
Turning

L513
Seat to Suit Turning Tool
Holders

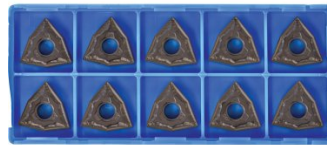
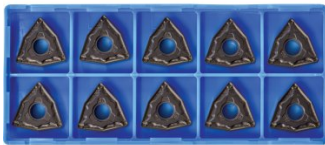

L514
Pin to Suit Turning Tool Holders

L515
Clamp to Suit Turning Tool
Holders

L516
Clamp Screw to Suit Turning
Tool Holders

L450
Lathe Turning Tool Kit - 3 piece
Insert Type



Product Brochure For L039

L451
Lathe Turning Tool Kit - 3 piece
Insert Type



L452
Lathe Turning Tool Kit - 3 piece
Insert Type



L453
Lathe Turning Tool Kit - 3 piece
Insert Type



L072
HSS Turning Tool Set - 4 piece



L0085
Carbide Turning Tool Set - 11
piece



L0055
Lathe Turning Tool Kit - 5 piece
Insert Type



L0099
Lathe Turning Tool Kit - 7 piece
Insert Type



L0077
Lathe Turning Tool Kit - 7 piece
Insert Type



L456
Lathe Threading Tool Kit - Insert
Type



L457
Lathe Threading Tool Kit - Insert
Type



L458
Lathe Threading Tool Kit - Insert
Type



L459
Lathe Threading Tool Kit - Insert
Type



Product Brochure For L039

L464

Professional Lathe Parting Tool Kit - Insert Type



L465

Professional Lathe Parting Tool Kit - Insert Type



L466

Professional Lathe Parting Tool Kit - Insert Type



L467

Professional Lathe Parting Tool Kit - Insert Type



L006A

Boring Bar Set - HSS



L431

Boring Bar Set - Carbide Insert



L430

Boring Bar Set - Carbide Insert

