

Product Brochure For L044

Right Hand Turning Tool Holder - MTJNR-1616-H16

16mm Tool Height
Insert tip not included

On Sale

Ex GST	Inc GST
\$86.00	\$98.90
\$68.70	\$79.00



ORDER CODE:	L044
Part Number - Style:	MTJN
Tool Height Size (mm):	16
Clamping Method of Insert:	~
Category:	~
Connection style:	~
Back End Size:	~
Application:	~
Hand Type:	Right
Holder Style:	~
Clearance Angle:	~
Insert Type:	TNMG16
A (H) (mm):	16
B (mm):	16
C (LF) (mm):	100
LH (mm):	~
F (WF) (mm):	20
E (mm):	30



Description

Quality Tipped Tool Holders ISO Standard to suit Tungsten Carbide Indexable Insert Tips.

NOTE: Inserts not included with tool holders

Use insert TNMG 160408 (L064)

Features

- Negative rake turning tool holder with 93° approach angle
- Suitable for rapid metal removal
- Right hand tool holder suitable for turning towards the chuck

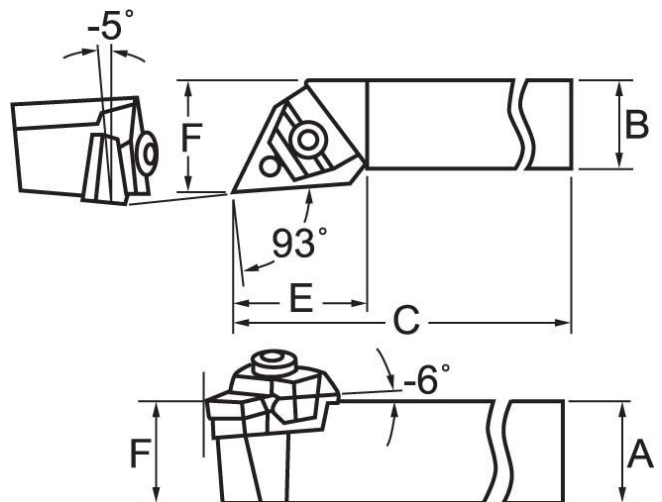

Product Brochure For L044

SETTING THE SPINDLE SPEED

To calculate the correct speed the following metric formula can be used

$$RPM = \frac{1000 \times \text{Surface speed in Metres per Minute}}{3.14 \times \text{Diameter in millimetres}}$$

Material	Approximate surface speeds for carbide tools	
	Roughing	Finishing
Mild Steel	50	80
Cast Iron	40	60
Aluminium	80	100
Stainless Steel	40	50

Example 1.
20mm Mild Steel bar to be rough machined

$$RPM = \frac{1000 \times 50}{3.14 \times 20mm} = \frac{50000}{62.8} = 796rpm$$

Example 2.
20mm Mild Steel bar to be finished machined

$$RPM = \frac{1000 \times 80}{3.14 \times 20mm} = \frac{80000}{62.8} = 1273rpm$$

- Set the spindle speed to the closest speed to the RPM calculated
- If in doubt then set a speed slower than the calculated speed

SETTING THE TOOL ON CENTRE

For the tool to cut correctly it needs to be set on centre. This can be best achieved by placing a centre in the tailstock and packing the tool until the tool is on centre.

Correct centre height



Incorrect centre height



Recommended Accessories

L0644
KYOCERA Carbide Inserts - Turning

L064
KYOCERA Carbide Inserts - Turning

L0648
KYOCERA Carbide Inserts - Turning

L527
Seat to Suit Turning Tool Holders



Product Brochure For L044

L5315
Seat Pin to Suit Turning Tool Holders



L535
Clamp to Suit Turning Tool Holders



L5365
Clamp Screw to Suit Boring Bar



L450
Lathe Turning Tool Kit - 3 piece Insert Type



L451
Lathe Turning Tool Kit - 3 piece Insert Type



L452
Lathe Turning Tool Kit - 3 piece Insert Type



L453
Lathe Turning Tool Kit - 3 piece Insert Type



L072
HSS Turning Tool Set - 4 piece



L0085
Carbide Turning Tool Set - 11 piece



L0055
Lathe Turning Tool Kit - 5 piece Insert Type



L0099
Lathe Turning Tool Kit - 7 piece Insert Type



L0077
Lathe Turning Tool Kit - 7 piece Insert Type



Product Brochure For L044

L456
Lathe Threading Tool Kit - Insert Type



L457
Lathe Threading Tool Kit - Insert Type



L458
Lathe Threading Tool Kit - Insert Type



L459
Lathe Threading Tool Kit - Insert Type

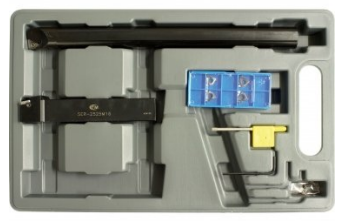

L464
Professional Lathe Parting Tool Kit - Insert Type



L465
Professional Lathe Parting Tool Kit - Insert Type



L466
Professional Lathe Parting Tool Kit - Insert Type



L467
Professional Lathe Parting Tool Kit - Insert Type



L006A
Boring Bar Set - HSS



L431
Boring Bar Set - Carbide Insert



L430
Boring Bar Set - Carbide Insert

