

Product Brochure For L059

Carbide Inserts - Milling - APMT 103504PDER-H

Grade ACZ330, General Purpose, 10mm
10 Inserts Per Pack

On Sale

Ex GST	Inc GST
\$184.00	\$211.60
\$146.96	\$169.00



ORDER CODE:	L059
ISO:	APMT 103504PDER-H
Grade:	ACZ330
t (mm):	3.3
m (mm):	~
a (mm):	~
b (mm):	~
l (mm):	~
d (mm):	9.75
d1 (mm):	6.2
R (mm):	0.4
Quantity of Inserts (No.):	10



Description

INDEXABLE INSERTS

Features

- ACZ330 - Coated grade: Suitable for general purpose milling in steels and stainless steel. Covers a range from P10-P30
- 10 Inserts Per Pack

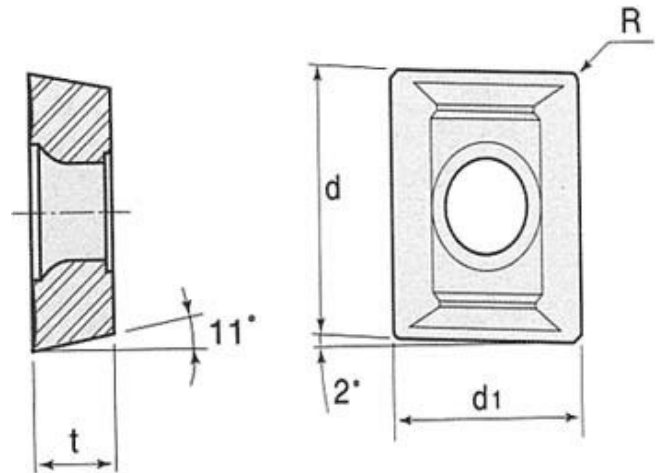

PVD Coated carbide

PVD coated carbide is based on a ceramic thin film coating and is suitable for very tough applications with some interrupted cutting. Ideal for excellent wear resistance and long life. Suitable for milling steel and stainless steel.

P10	P20	P30	P40	M10	M20	M30	M40	K10	K20	K30	K40
ACZ330				ACZ330				ACZ330			

Product Brochure For L059

Specific Features



Tip