

Product Brochure For L201

Centre Lathe - AL-1324

Ø330 x 600mm Turning Capacity - Ø40mm Spindle Bore



On Sale - Back In Stock Soon

Ex GST

Inc GST

\$15,068.00

\$17,328.20

\$14,600.00

\$16,790.00

ORDER CODE:	L201
MODEL:	AL-1324
Swing Over Bed (mm):	330
Distance Between Centres (mm):	600
Spindle Bore (mm):	40
Swing In Gap (mm):	~
Swing Over Cross-slide (mm):	200
Digital Readout System Fitted:	Optional
Quick Change Toolpost Fitted:	Optional
Leadscrew Covers Fitted:	Yes
Taper Turning Attachment:	Optional
Coolant System:	Yes
Tool Height To Suit (mm):	16
Centre Height (mm):	165
Spindle Nose Size or Type:	D1-4 Camlock
Bed Width (mm):	190
Headstock Spindle Taper (MT):	5
Tailstock Taper (MT):	3
Cross Slide Travel (mm):	175
Compound Slide Travel (mm):	100
Leadscrew Type:	Metric
Metric Cross Feed (X-Axis) (mm/rev):	0.034 - 0.468
Imperial Cross Feed (X-Axis) (inch/rev):	~
Metric Longitudinal Feed (Z-Axis) (mm/rev):	0.068 - 0.936
Imperial Longitudinal Feed (Z-Axis) (inch/rev):	~
Metric Thread Steps & Pitch (No. / mm):	30(0.4 - 7.0)
Imperial Thread Steps & TPI (No. / TPI):	32(4 - 56)
3 Jaw Chuck Diameter (mm):	160
4 Jaw Chuck Diameter (mm):	200
Spindle Steps / Speeds (No. / rpm):	18 (50 - 2000)
Motor Power (kW / hp):	2.25 / 3
Voltage / Amperage (V / amp):	415
Nett Weight (kg):	580

Description

Manufactured in Taiwan

Features

- Tool room quality precision lathe, Made in Taiwan and have been sold for over 20 years
- Gear drive headstock for quick change of spindle speeds
- Nachi Japanese made bearings supporting headstock spindle
- Stand increasing rigidity and reducing vibration
- Precision 'V'-beds are hardened and ground, incorporating a rigid webbed casting
- Foot operated spindle brake with safety cut out switch
- Slide out front swarf tray for easy cleaning
- Chuck guard fitted fitted with micro switch
- Leadscrew cover ensures swarf not reaching clasp nut
- Change gears for metric and imperial thread cutting
- Oil sight glass for head stock and gearbox

Product Brochure For L201

- Adjustable taper roller bearings support the spindle
- Overload clutch mechanism on auto power feed
- Overload protection on drive motor and coolant system
- 3HP/415V motor, 18-speed (50 - 2000rpm)
- Enclosed quick action gearbox for thread cutting and auto feeding
- Powered longitudinal and cross feeds
- D1-4 camlock spindle for quick chuck changes and safe reverse-direction turning. ISO standard
- Dual calibrated dials
- Coolant system with flexible hose
- Slide out swarf tray

Includes

- 3-jaw chuck with reverse jaws
- 4-jaw chuck
- Faceplate
- Fixed Steady
- Travelling steady
- Chuck guard
- Concertina leadscrew covers
- Slide out front swarf tray
- Dead centre
- Thread chasing dial
- Foot brake
- Coolant system
- Rear splash guard
- Instruction booklet

Specific Features



Left View

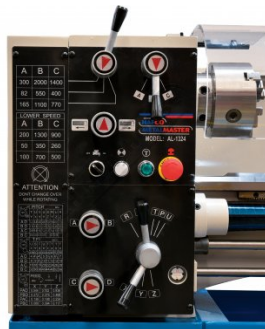

Headstock



Spindle Speed Levers

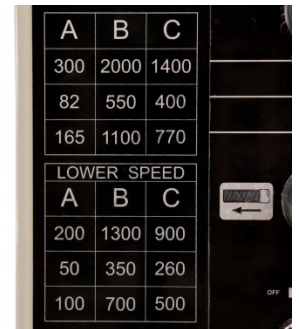

Spindle Speed Chart



Enclosed Quick Change Gearbox

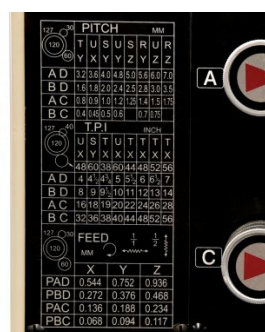

Product Brochure For L201



Safety Chuck Guard Up



Foot Brake



Sliding Drip Tray for Swarf Removal



3 Jaw Chuck



Fixed and Travelling Steadies

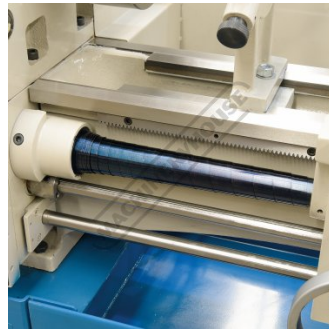

Leadscrew Cover Front



Leadscrew Cover Rear



Flexible Coolant Hose

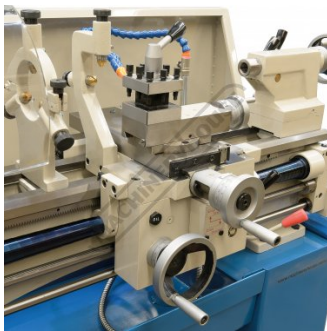

Saddle Left View

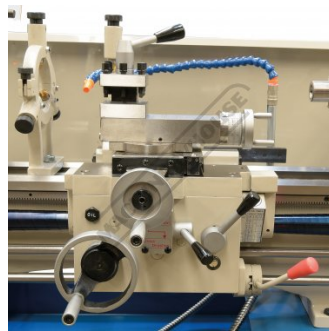

Saddle Front View



Saddle Right View

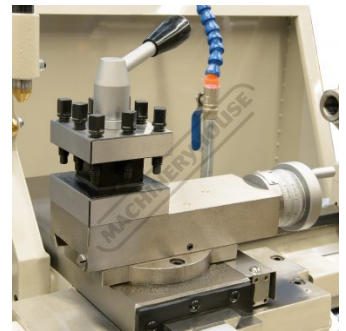

4-Way Toolpost



Thread Chasing Dial

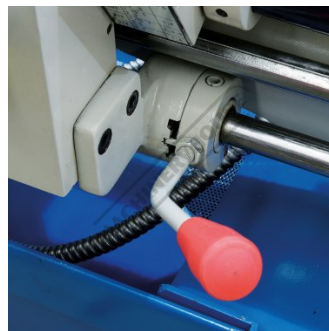

Forward Reverse Spindle Lever



Feed Levers



Swivel Compound Slide

Product Brochure For L201



Cross Slide Hand Wheel

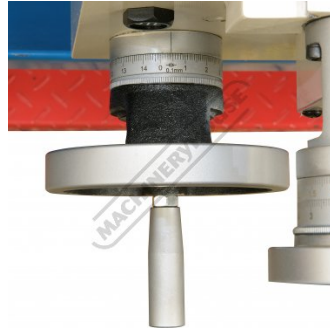

Saddle Hand Wheel

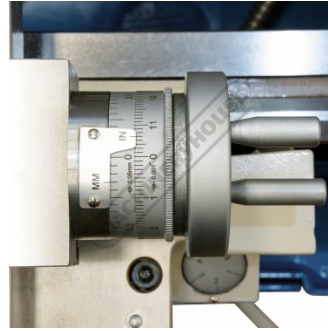

Compound Slide Hand Wheel

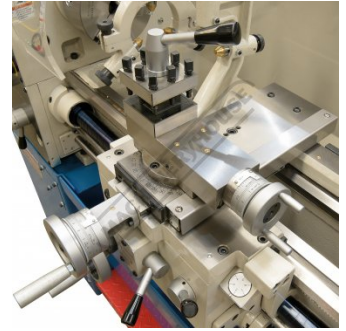

Compound Slide



Tailstock

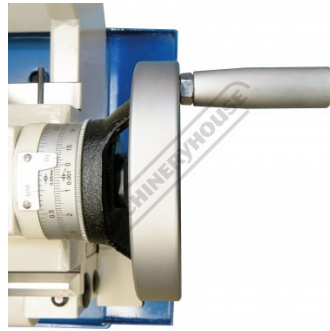

Tailstock Hand Wheel



Tailstock Quill Graduations



Tailstock Horizontal Adjustment



Hardened and Ground Bedways



Bed Drip tray



Toolbox

Product Brochure For L201

Recommended Accessories

Q8500
3-Axis Digital Readout



Q8512
220mm Digital Readout Scale



Q8530
620mm Digital Readout Scale



L258
Taper Turning Attachment



L277
Vertical Mill Slide



C980
5C Collet Lathe Adaptor



L295
Quick Change Toolpost



L017
Right Hand Turning Tool Holder



Product Brochure For L201

L018
Left Hand Turning Tool Holder



L044
Right Hand Turning Tool Holder



L045
Left Hand Turning Tool Holder



L0077
Lathe Turning Tool Kit - 7 piece Insert Type



L451
Lathe Turning Tool Kit - 3 piece Insert Type



L457
Lathe Threading Tool Kit - Insert Type



L465
Professional Lathe Parting Tool Kit - Insert Type



C052
3MT Live Centre



C045
3MT Pipe Centre - 70° Cone



L076
Knurling Tool Holder Kit



C290
Heavy Duty Drill Chuck - Keyed Type



C294
Industrial Drill Chuck - Keyless Type



Product Brochure For L201

D443A
3MT x JT3 Drill Chuck Arbor



D126
Metric 135° Precision HSS Drill Set - 170 Pieces



D1282
Imperial 135° Precision HSS Drill Set - 29 Piece



S090A
Soluble Metal Cutting Fluid - 1 Litre



S090
Soluble Metal Cutting Fluid - 5 Litre



S076
Cutting Tool Lubricant Fluid - 500ml



S077
Drilling, Tapping & Cutting Tool Lubricant Spray - 400g



S074
Cutting Tool Lubricant Paste - 500g



L341
Fitting and Machining Technical Book

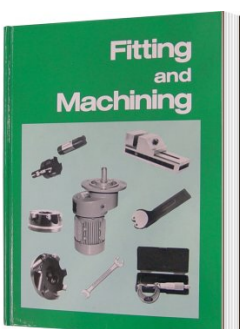

L345
Handy Workshop Tips & Techniques - 1st Edition

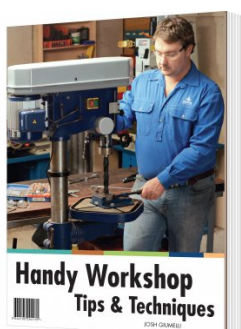

L3455
Professional Sheet Metal Fabrication Book

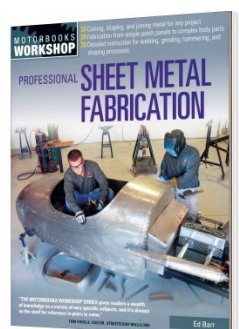

L300
Magnetic Swarf Remover



Product Brochure For L201

M9991
Magnetic Floor Sweeper



M800
Rubber Mat - Anti-Fatigue



M805
Rubber Mat - Anti-Fatigue

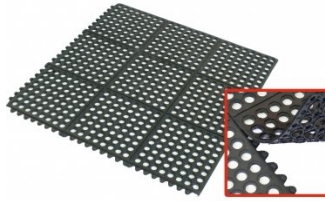

O043
Rust & Corrosion Preventive



O042
General Purpose Lubricant &
Corrosion Inhibitor



O044
Rust & Corrosion Preventive

