

Product Brochure For L830

Roller Conveyor with Adjustable Stands - Heavy Duty - RC-450HD

540 x 3000mm
Ø60mm Rollers

On Sale

Ex GST	Inc GST
\$1,330.00	\$1,529.50
\$980.00	\$1,127.00



ORDER CODE:	L830
MODEL:	RC-450HD
Roller Width (mm):	450
Roller Pitch (mm):	300
No. Rollers (No.):	10
Roller Diameter (mm):	Ø60
Frame Length (L) (mm):	3000
Frame Width (W) (mm):	540
Frame Height (H) (mm):	80
Height Adjustment (mm):	600 - 950
Load Capacity with 2 x Support Legs (kg):	~
Load Capacity with 3 x Support Legs (kg):	1200

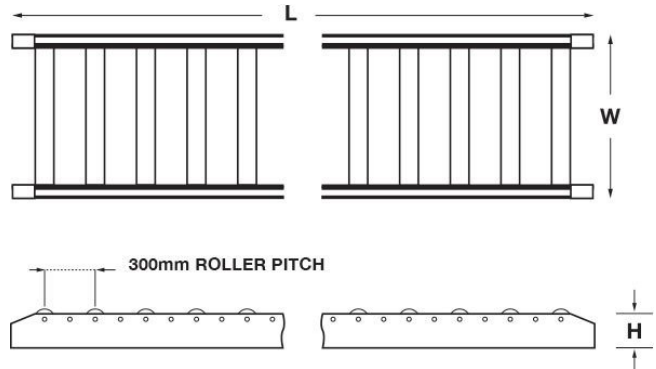

Features

- Roller capacity of 200kg each
 - 10 x Zinc plated steel rollers at 300mm pitch
 - Rollers are 450mm wide x Ø60mm with commercial bearings
 - Frame is constructed from steel channel for addition strength
 - Adjustable roller table height 600-950mm
 - 3 x stands with adjustable levelling pads
 - Frames are pre-drilled at 150mm pitch to accept "Optional 9 rollers" totalling to 19 rollers
- Please Note:
- Roller load capacity is calculated on even weight distribution over entire roller
 - Total load capacity is calculated on even weight distribution over entire roller conveyor system

Includes

- 10 steel rollers @ 300mm pitch
- 3 x heavy duty adjustable stands

Product Brochure For L830

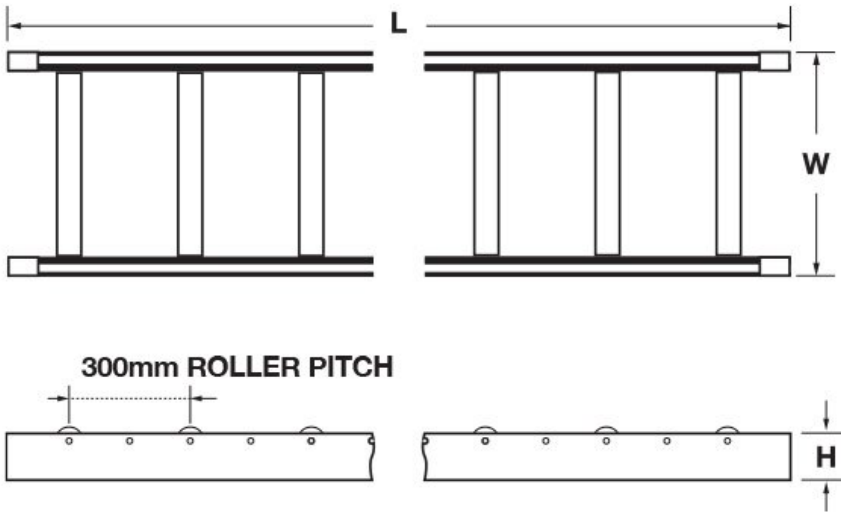

Specific Features



Legs



Adjustable Feet

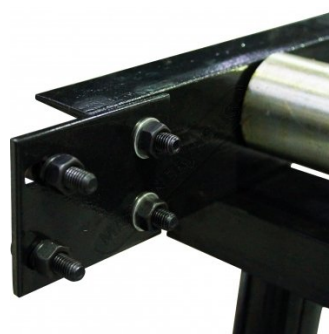

Bracket



Heavy Duty Frame

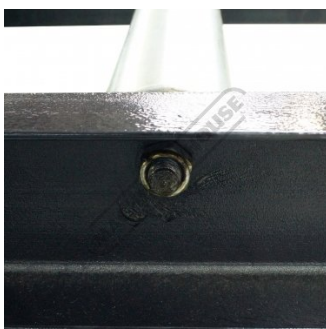

Heavy Duty Roller Axle

Product Brochure For L830

Recommended Accessories

L831

Steel Conveyor Roller

L835

Roller Conveyor with Adjustable
Stands - Extra Heavy Duty

