

Product Brochure For M518

Face Mill 45° - Super High-Rake - F45SE12-D100

Ø100mm

Insert tip not included

On Sale

Ex GST	Inc GST
\$258.00	\$296.70
\$205.22	\$236.00



ORDER CODE:	M518
MODEL:	F45SE12-D100
Cutter Approach Angle (deg):	45°
D (mm):	100
D1 (mm):	114
H (mm):	50
d (lowercase):	32mm
Drawbar Thread:	-
Number of Inserts (No.):	6
Replacement Insert Tips:	(L065)
Nett Weight (kg):	1.85



Description

SUPER HIGH-RAKE FACE MILL - 100mm x 45°
Use carbide inserts (ISO) SEKT1204 (L065)
NOTE: Carbide Inserts not included

Features

- Suitable for low horsepower machines where rapid metal removal is required.
- Suitable for steel, cast iron and non-ferrous metals
- Positive rake

Includes

- Lock key for insert

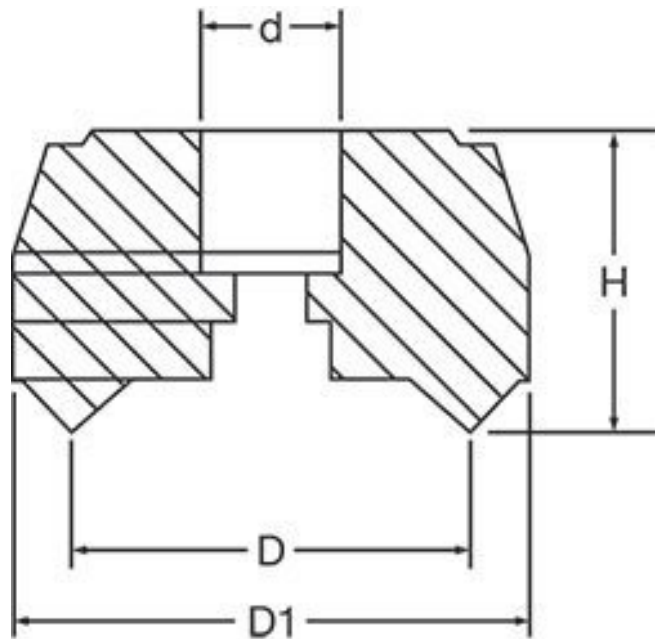

Product Brochure For M518

Recommended Accessories

L065

KYOCERA Carbide Inserts -
Milling



ML090

Cutter Part - Screw



L538

Key to Suit Tool Holder



M537

Face Mill Arbor



M544

Face Mill Arbor



M554

Face Mill Arbor



T158

BT40-FMB32-45 Face Mill Arbor

