

Product Brochure For M726

Vernier Caliper

300mm / 12"
Fine Adjuster



On Sale

Ex GST
~~\$66.00~~
\$53.91

Inc GST
~~\$75.90~~
\$62.00

ORDER CODE:	M726
Range:	300mm / 12"
Graduations:	0.02mm / 0.001"
Accuracy (mm):	±0.04
A (mm):	60
B (mm):	29
C (mm):	22
D (mm):	19
L (mm):	416
4 Way (Yes / No):	Yes



Features

- Manufactured from stainless steel
- Measuring faces are ground and lapped
- Graduations are clear and easy to read
- Both metric and imperial graduations
- Fine Adjustment
- All models have a position lock

Product Brochure For M726

Specific Features

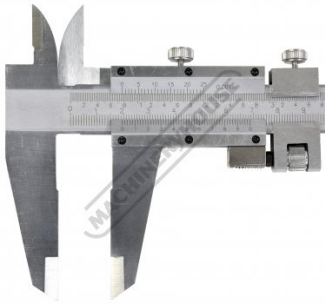

Internal-External Measuring Jaws

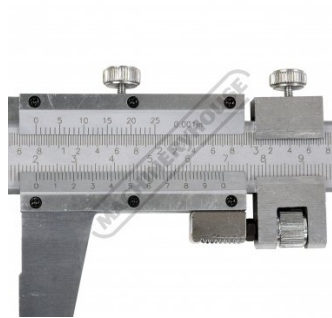

Vernier Head Lock Screw-Fine Adjustment

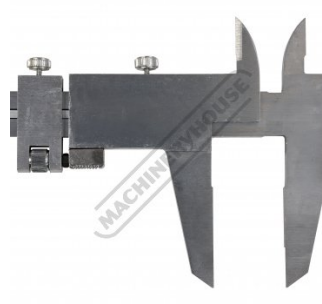

Height Measuring Slide

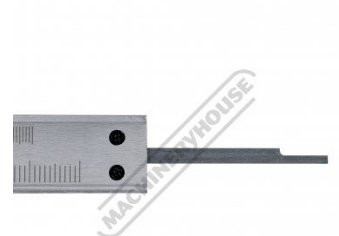

Depth Measuring Blade



Metric-Imperial Scale