

Product Brochure For N004

Rivet Nut Inserts - M4 x 0.7mm

Steel - Zinc Plated
Qty 50 In Pack

On Sale

Ex GST
~~\$12.00~~
\$10.17

Inc GST
~~\$13.80~~
\$11.70



ORDER CODE:	N004
MODEL:	~
Type:	~
Nut Insert Material (Type):	Steel - Zinc Coated
Quantity in Pack:	50
Rivet Nut Inserts Range (Metric):	~
Blind Rivets (mm):	~
Thread Size (T) (Metric):	M4 x 0.5
Thread Length (TL) (Metric):	~
Length (L) (mm):	10.5
Head Height (HH) (mm):	0.75
Head Diameter (HD) (mm):	9
Diameter (D) (mm):	5.8
Hole Size (HS) (mm):	6
Grip Range (GR) (mm):	0.25 - 2.50
Torque to Turn (Kgf.cm):	55



Description

Suits ATR-10RN Air Operated or RNB40 Twin Handle Nut Riveters

Features

- Steel - Zinc Coated
- Fast & easy installation from one side
- Adds a threaded nut to thin sheet metal
- Knurled section under nut head for anti-rotation
- Easy to install
- ** NOTE: When used with RNB40 Nut Riveter, the M4 Nut Rivet Mandrel and Adaptor is required, sold separately (Order Code: N0022)

Includes

- 50 x Rivet Nuts Inserts - M4 x 0.7mm

NUT INSERT

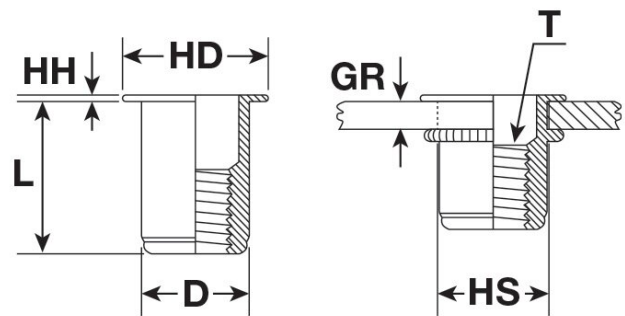

UNINSTALLED

INSTALLED

Product Brochure For N004

Specific Features



Packaging Front



Packaging Back

Recommended Accessories

N001
Nut & Blind Riveter Set - 130
Piece



N0022
NUT RIVET MANDREL &
ADAPTOR



N006
Rivet Nut Inserts - M6 x 1.0mm



N008
Rivet Nut Inserts - M8 x 1.25mm



N010
Rivet Nut Inserts - M10 x 1.5mm



N015
Rivet Nut Inserts - M5 x 0.8mm



N016
Rivet Nut Inserts - M6 x 1.0mm



N018
Rivet Nut Inserts - M8 x 1.25mm



Product Brochure For N004

N020

Rivet Nut Inserts - M10 x 1.5mm

