

Product Brochure For N006

Rivet Nut Inserts - M6 x 1.0mm

Steel - Zinc Plated
Qty 50 In Pack

On Sale

Ex GST
~~\$16.00~~
\$13.91

Inc GST
~~\$18.40~~
\$16.00



ORDER CODE:	N006
MODEL:	~
Type:	Rivet Nut Inserts
Nut Insert Material (Type):	Steel - Zinc Coated
Quantity in Pack:	50
Rivet Nut Inserts Range (Metric):	~
Blind Rivets (mm):	~
Thread Size (T) (Metric):	M6 x 1.0
Thread Length (TL) (Metric):	~
Length (L) (mm):	14.4
Head Height (HH) (mm):	1.5
Head Diameter (HD) (mm):	13.1
Diameter (D) (mm):	8.9
Hole Size (HS) (mm):	9
Grip Range (GR) (mm):	0.75 - 3.00
Torque to Turn (Kgf.cm):	130



Description

Suits ATR-10RN Air Operated or RNB40 Twin Handle Nut Riveters

Features

- Steel - Zinc Coated
- Fast & easy installation from one side
- Adds a threaded nut to thin sheet metal
- Knurled section under nut head for anti-rotation
- Easy to install

Includes

- 50 x Rivet Nut Inserts - M6 x 1.0mm

NUT INSERT

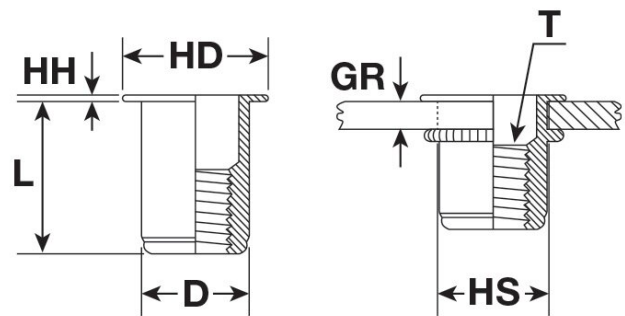

UNINSTALLED

INSTALLED

Product Brochure For N006

Specific Features



Packaging Front



Packaging Rear Side

Recommended Accessories

N001
Nut & Blind Riveter Set - 130
Piece

N005
Rivet Nut Inserts - M5 x 0.8mm

N008
Rivet Nut Inserts - M8 x 1.25mm

N010
Rivet Nut Inserts - M10 x 1.5mm



N015
Rivet Nut Inserts - M5 x 0.8mm

N016
Rivet Nut Inserts - M6 x 1.0mm

N018
Rivet Nut Inserts - M8 x 1.25mm

N020
Rivet Nut Inserts - M10 x 1.5mm

