

Product Brochure For P721

Ø21mm Round Punch - RPN1

Hi -Grade Tool Steel Imported From Japan

On Sale

Ex GST

\$62.00

\$47.83

Inc GST

\$71.30

\$55.00



| | |
|--------------------------|-------|
| ORDER CODE: | P721 |
| MODEL: | RPN1 |
| Type: | Punch |
| Punch Diameter (D) (mm): | Ø21 |
| Die Diameter (D) (mm): | ~ |
| Pack Quantity (No.): | 1 |



Description

Punch and Dies are Manufactured by Sunrise in Taiwan using Hi -Grade Tool Steel imported from Japan. The manufacturing process involves machining via hi tech CNC machines lathes & mills, vacuum heat treatment with multiple tempering at high temperatures before a final quality inspection/testing process all of which ensures an accurate, precise, durable & stable product.

Features

- PLEASE NOTE FOLLOWING RECOMMENDATIONS WHEN SELECTING DIE CLEARANCE:
- Material Thickness - 2 ~ 4mm = Die Clearance 0.2mm
- Material Thickness - 4 ~ 9.5mm = Die Clearance 0.7mm
- Material Thickness - 10 ~ 14.5mm = Die Clearance 1.2mm
- Material Thickness - 15 ~ 19.5mm = Die Clearance 1.7mm
- Material Thickness - 20 ~ 24mm = Die Clearance 2.2mm

Optional Accessories

- Other sizes and shapes available on request

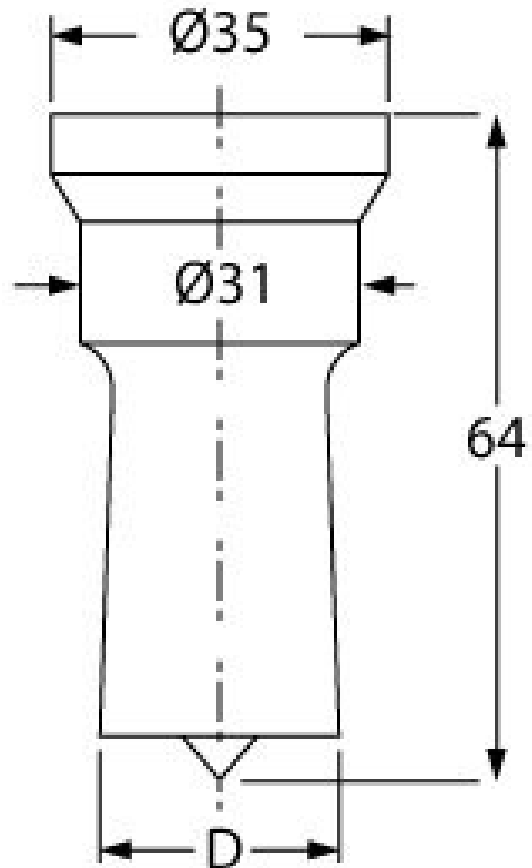

Product Brochure For P721

Recommended Accessories

P721B
Ø21.2mm Round Die - RDN1

P721A
Ø21.7mm Round Die - RDN1

P722B
Ø22.2mm Round Die - RDN1

P722A
Ø22.7mm Round Die - RDN1



P723B
Ø23.2mm Round Die - RDN1

