

Product Brochure For Q105

Metric Outside Micrometer - 10-105

25 - 50mm Range

On Sale

Ex GST

~~\$68.00~~

\$53.04

Inc GST

~~\$78.20~~

\$61.00



ORDER CODE:	Q105
Range (mm):	25 - 50
Graduation (mm):	0.01
Accuracy (mm):	0.004
Setting Bar (No.):	1
a (mm):	14
b (mm):	3
c (mm):	38
L (mm):	57
m061:	~

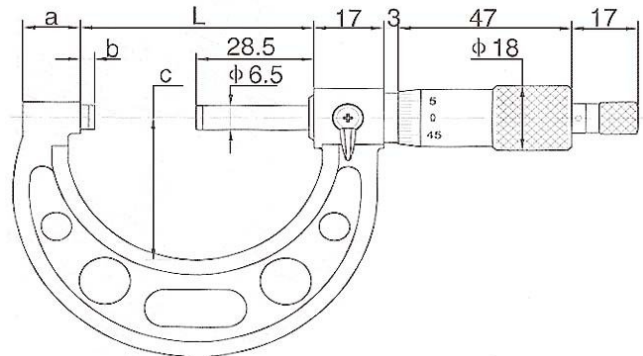

Description

Measumax metric micrometers represent exceptional value. Special care has been taken in design and workmanship to ensure high precision and long life. Measumax metric micrometers meet industry standards for specification and accuracy

Features

- Carbide measuring faces - Painted cast frame
- Micro-fine clear graduations on satin chrome finish
- Measuring face 6.5mm, Flatness 0.0008mm
- Ratchet stop for exact repetitive readings
- Includes deluxe foam lined plastic case and wrench
- Graduation 0.01mm
- Supplied with setting standards