

Product Brochure For Q145

Depth Micrometer - 22-145

0-50mm
Metric

On Sale

Ex GST

Inc GST

\$220.00

\$253.00

\$175.65

\$202.00



ORDER CODE:	Q145
Range (mm / inch):	0 - 50mm
Graduation (mm):	0.01
Accuracy (mm / inch):	±0.004mm
A (mm / inch):	100mm
Rods (No.):	2

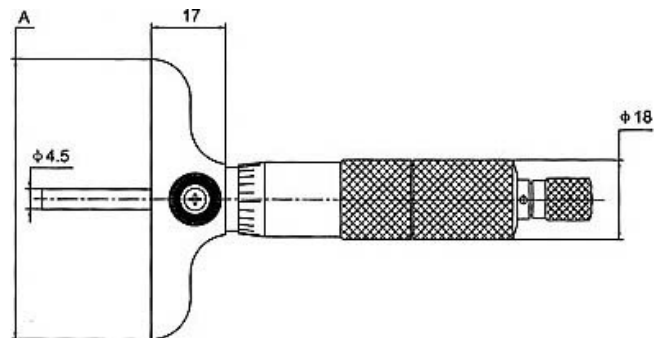

Features

- High accuracy interchangeable rods with hardened and micro lapped flat anvils, provide a wide measuring range
- The interchangeable rods are held securely under the top ratchet section and have individual adjustment for resetting if required
- The base is hardened, ground and lapped for accuracy
- Ratchet stop for exact repetitive readings
- Positive locking clamp
- Graduation: 0.01mm

Product Brochure For Q145

Specific Features



Graduations



Measuring Example



Figure 1



Figure 2



Figure 3