

Product Brochure For Q8513

270mm Digital Readout Scale - MX-500-270/5U

MX-500 Compact Scale
5µm Resolution

On Sale

Ex GST

~~\$220.00~~
\$175.65

Inc GST

~~\$253.00~~
\$202.00

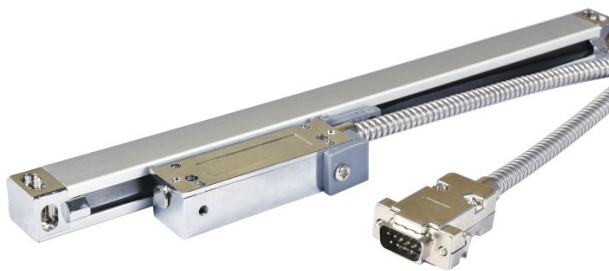

ORDER CODE:	Q8513
MODEL:	MX-500
Type:	Compact Linear Scale
Travel - Maximum (mm):	270
Overall Length (L) (mm):	382
Scale Resolution (µm):	5µm (0.005mm)
Grating Pitch:	20µm (0.02mm)
Accuracy (µm):	±0.005mm?±0.01mm/M
Output Signal:	5V TTL
Connector:	9 pin D-Sub
Cable Length (Metre):	3m metal conduit
Working Temperature (°C):	-10?—60?
Sealing Protection Class:	Class: IP54
Maximum Speed (M/min):	60M/Min
Reference Point:	Every 50mm
Width x Height (W x H) (mm):	~
Backing Support Plate (Yes / No):	Yes



Description

The Measumax MX-500 compact series linear scales have a 5µm resolution and a response speed of 60m/min delivering 100% accuracy. The compact 18 x 20mm (W x H) section size makes them ideal for limited space installations.

Features

- NSK Japanese, five bearing 45° sliding structure for a smooth and accurate movement along the length of the scale
- Glass scale with 5µm resolution
- Scale body made from extruded Aluminium with wiper seals providing IP54 protection
- Compact 18 x 20mm (W x H) section, ideal choice for applications with limited space.
- 3m connection cable with 9 pin D-Sub connector

Includes

- 270mm Linear scale
- Scale cover
- 1 x Y-Axis 'E2' Bracket Slotted and Tapped (35x70x10mm)
- Screws and washers

Product Brochure For Q8513

MeasumaX^{MX}

MX-500 Series - COMPACT LINEAR SCALES

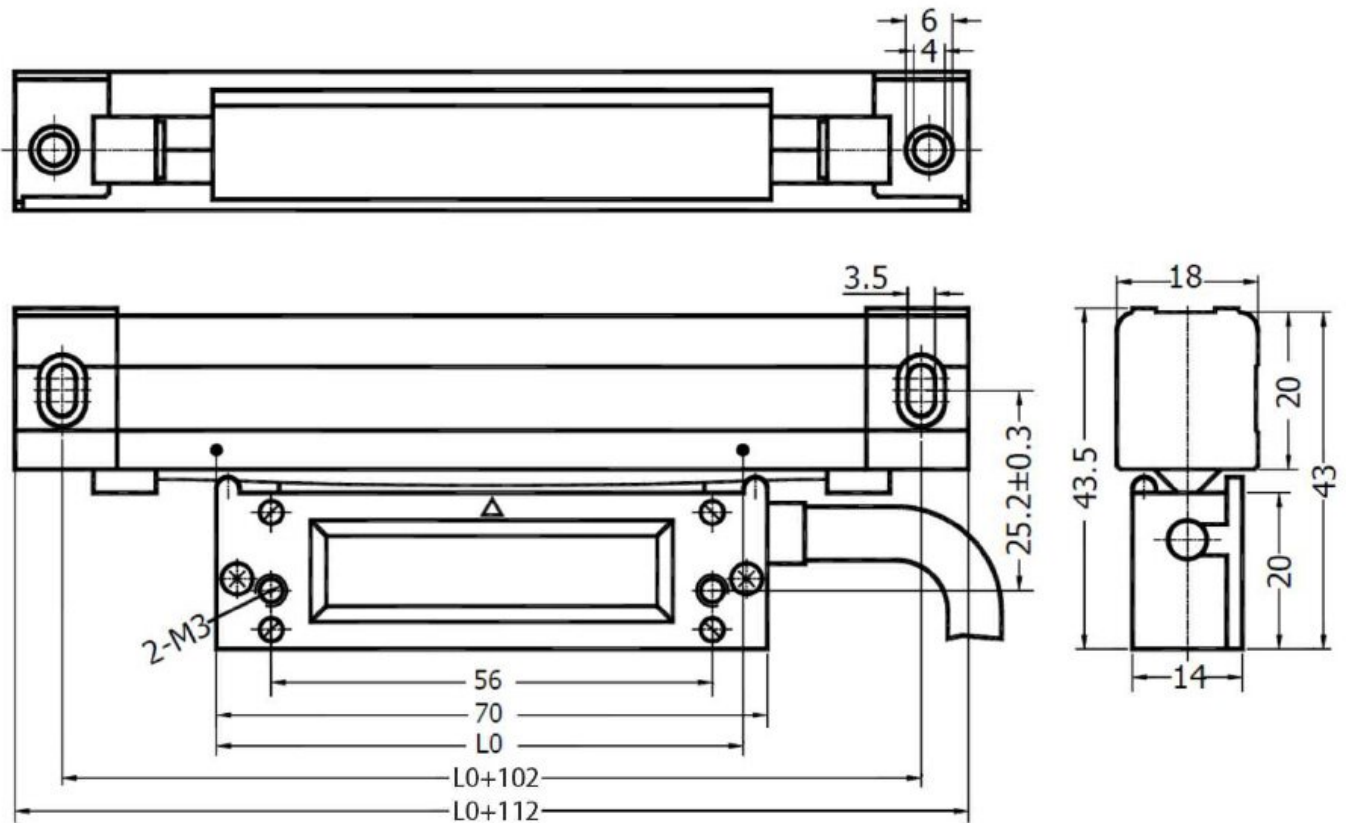

L0 = Effective measuring length of scale

Product Brochure For Q8513

Specific Features



Scale Covers



Mounting Bracket

Recommended Accessories

Q8500
3-Axis Digital Readout

D709
Easson Scales - Extension
Cable

D710
Easson Scales - Extension
Cable

