

Product Brochure For T002

Reversible Tapping Chuck - K2-MT2

Include 2MT Fixed Arbor

M5 - M10



Description

Manufactured in Taiwan

Suits drilling and milling machines

Features

- Clutch device permits smooth drive and reverse
- Pre-set depth control minimises possibility of tap breakage
- Cushioned drive prevents thread distortion and cross-threading when tapping in two operations
- Cushioned reverse provides smooth and vibration-free transition between forward and reverse drive

ORDER CODE:	T002
MODEL:	K2-MT2
Arbor Mount:	Fixed
Taper (MT):	2
Tapping Range (mm):	5 - 10
Tapping Shank Size (mm):	~
D (mm):	95
D1 (mm):	34
L (mm):	230
L1 (mm):	165
A (mm):	65
B (mm):	11
Nett Weight (kg):	1.82

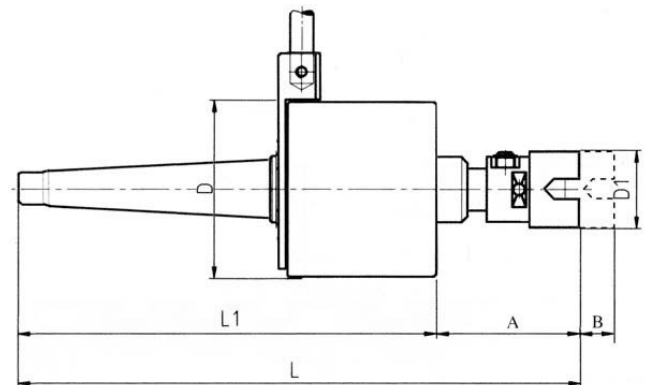

Product Brochure For T002

Recommended Accessories

T012

Metric Alloy Steel Tap & Die Set
- 32 Piece



T013

Metric HSS Tap & Die Set - 32
Piece



T014

Metric Alloy Steel Tap & Die Set
- 45 Piece



T015

Imperial Alloy Steel Tap & Die
Set - 45 Piece



T016

Metric HSS Tap & Die Set - 45
Piece

