

Product Brochure For T773

## Industrial Mobile Tooling Cabinet Workstation - WTC-1450

1170 x 580 x 1450mm  
100kg per Drawer

**On Sale**

Ex GST	Inc GST
<del>\$1,330.00</del>	<del>\$1,529.50</del>
<b>\$1,000.00</b>	<b>\$1,150.00</b>



ORDER CODE:	T773
MODEL:	WTC-1450
Number of Drawers (No.):	5
Drawer Load Capacity (kg):	100
Maximum Total Load Capacity (kg):	390
Includes Backing Panel:	~
Dimensions (W x D x H) (mm):	1170 x 580 x 1450
Nett Weight (kg):	121



### Features

- Heavy duty tooling cabinets, ideal for industrial applications and serious workshops
- Backing panel perfect for optional hooks, prongs & holders
- The sliding drawers are a welded strengthened single rail design coupled with high quality mechanical bearings for long lasting smooth operation
- 5 Drawers, top drawers include a series of different size plastic boxes for those small items, all other drawers come with adjustable steel dividers
- 100kg load capacity per drawer with 97% access
- 250kg load capacity on work bench top
- 390kg total load capacity for mobile work station
- Key lockable drawers & cupboard
- Cupboard consist an adjustable shelf with a load capacity of 40kg
- Powder coated quality finish
- 950mm work bench height
- Portable on caster wheels, 2 with brake
- Includes push handle
- Table Dimensions (W x D x H): 1103 x 580 x 950mm
- Weighs 121kg

Product Brochure For T773

**Specific Features**



Shown with Optional Tools and Accessories



Front View



Side View



Cupboard with Adjustable Shelf



Top Drawer



2nd Drawer



Bottom Drawers



Key Lockable Drawers



Key Lockable Door



Fixed Wheels



Swivel Wheels



Push Handle



Rubber Matting



Drawer Railings



Drawer Locking Mechanism



Drawers with Safety Locks

Product Brochure For T773



Heavy Duty Drawers



Drawer Lock Bracket



Drawers with Steel Dividers



Top Drawer with Plastic Buckets



Backing Panel Shown with Optional Hooks

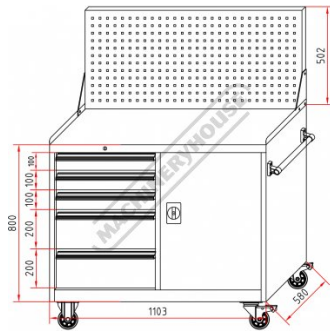

Diagram

**Recommended Accessories**

T786  
Steel Divider



T788  
Steel Divider



T786A  
Slotted Rail



T788A  
Slotted Rail



Product Brochure For T773

A439

Hook - Single Prong



A440

Hook - Single Prong

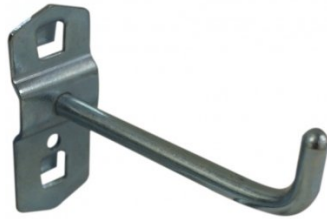

A4401

Hook - Single Prong



A441

Hook - Double Prong



A442

Hook - Double Prong

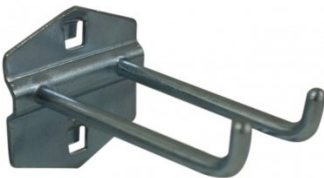

A4492

Hook - U Shape Holder



A449

Hook - U Shape Holder

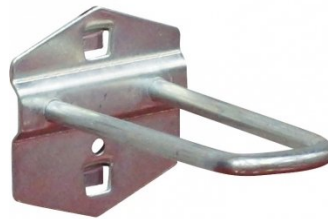

A4496

Round Tool Holder - Loop



A444

Plier Holder - Triple Prong



A446

Holder - Spanner

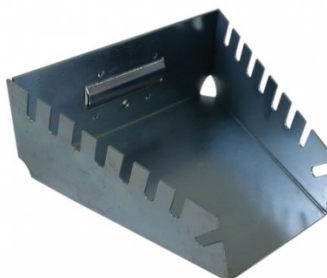

A448

Holder - Screwdriver

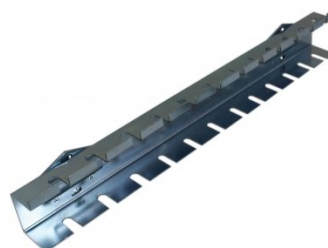

A427

Plastic Bucket



Product Brochure For T773

A428  
Plastic Bucket



A429  
Plastic Bucket



T703  
Magnetic Spray Can & Screwdriver Holder



H820  
Metric Hex Key Set with T-Bar Handle



H821  
Imperial Hex Key Set with T-Bar Handle



H822  
Torx® Key Set with T-Bar Handle



D1272  
Metric 135° Precision HSS Drill Set - 25 Piece



D1282  
Imperial 135° Precision HSS Drill Set - 29 Piece



D1285  
Metric 135° Precision HSS Drill Set - 51 Piece



D1071  
HSS Sheet Metal Step Drill Set - 3 Piece



D1051  
HSS Countersink Set (90° Cross Hole Type) - 4 Piece



D1061  
HSS Countersink Set (90° 3 Flute Type) - 6 Piece



Product Brochure For T773

**D508**  
HSS Industrial Centre Drill Set – 5Pcs



**D070**  
Drill Sharpener



**H880**  
Dead Blow, Nylon Face Hammer



**H870**  
Soft Face Hammer



**H875**  
Soft Face Hammer - 5 piece



**H885**  
Auto Panel Restoration Kit - DIY



**H886**  
Auto Panel Restoration Kit - Professional



**H887**  
Auto Panel Restoration Kit - Master



**M988**  
Metric & Imperial Drill Gauge

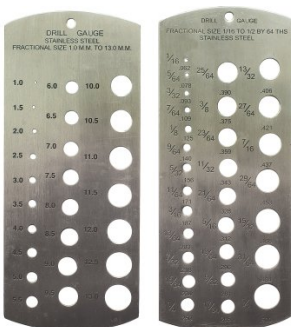

**Q616**  
Feeler Gauge Set



**T012**  
Metric Alloy Steel Tap & Die Set - 32 Piece



**T013**  
Metric HSS Tap & Die Set - 32 Piece



Product Brochure For T773

T014

Metric Alloy Steel Tap & Die Set - 45 Piece



T015

Imperial Alloy Steel Tap & Die Set - 45 Piece



T016

Metric HSS Tap & Die Set - 45 Piece



T870

Screw Extractor Set - 10 piece



T100

Metric Thread Repair Kit - 130 Piece



D108

Metric Carbide Tipped Hole Saw Set



D102

Metric HSS Hole Saw Set



F100

Engineers Files, 5 Piece Set - Second Cut



F120

Engineers File, Flat - Coarse Cut



F121

Engineers File, Flat - Second Cut



F122

Engineers File, Flat - Smooth Cut



F124

Engineers File, Half Round - Coarse Cut



Product Brochure For T773

F125

Engineers File, Half Round - Second Cut



F126

Engineers File, Half Round - Smooth Cut



F127

Engineers File, Round - Coarse Cut



F128

Engineers File, Round - Second Cut



F129

Engineers File, Round - Smooth Cut



F160

Slapping File - Second Cut



F150

Flexible Body File Holder



F155

Flexible Body File



F156

Flexible Body File



P112

Hole Punch Set



S203

180° Straight Edge/Seaming Plier



S205

90° Edge/Seaming Plier



Product Brochure For T773

**S200**  
Joggler & Punch Plier



**P368**  
Automatic Centre Punch



**P367**  
Centre Punch Set - 3 Piece



**P365**  
Pin Punch Set - 6 Piece



**P363**  
Cold Chisel Set - 3 Piece



**P364**  
Punch & Cold Chisel Set - 14 Piece



**N001**  
Nut & Blind Riveter Set - 130 Piece



**P350**  
Letter Punches



**P351**  
Number Punches



**P354**  
Letter Punches



**P355**  
Number Punches



**W103**  
Engineers Chalk Marker- 50 Splits



Product Brochure For T773

**D063**  
Sheet Metal Deburring Tool



**D060**  
Deburring Tool - Telescopic Shaft



**D065**  
Universal Deburring Tool Set - 23 Piece



**D068**  
Pipe/Tube Deburring Tool - Internal / External



**B900**  
Carbide Burr Double Cut Set - Short Series



**B905**  
Carbide Burr Double Cut Set - Long Series



**M0010**  
Pick Up Tool with Magnetic Head & 1 x LED Light

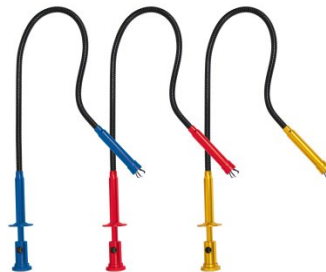

**M0009**  
Magnetic Pick Up Tool & Inspection Mirror Set



**L300**  
Magnetic Swarf Remover



**P020**  
Hydraulic Chassis Punch Set



**W112**  
Micro Welding Steel Clamp Set



**W113**  
Butt Welding Aluminium & Steel Clamp Set



Product Brochure For T773

S077

Drilling, Tapping & Cutting Tool Lubricant Spray - 400g



O043

Rust & Corrosion Preventive



O042

General Purpose Lubricant & Corrosion Inhibitor



O044

Rust & Corrosion Preventive



P030

Bush Driver Set - 17 piece



P031

Bearing Race & Seal Driver Set - 10 piece



P005

Ratcheting Gear Puller Set



P013

Puller Set with Slide Hammer



P011

Hydraulic Gear Puller Kit



A037

Air Tool Oil

