

Product Brochure For V126

Drill Press Vice - Standard

152mm Jaw Width
145mm Jaw Opening

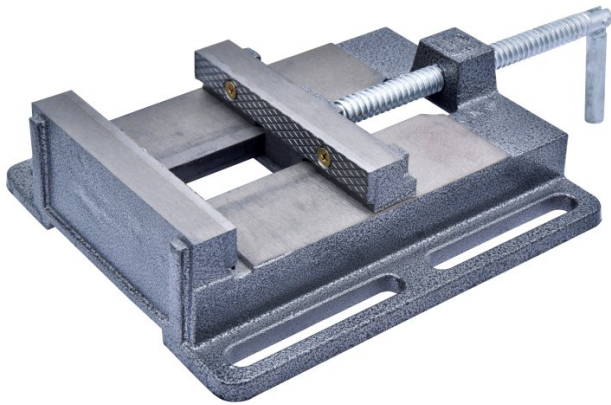

On Sale

Ex GST
~~\$56.00~~
\$43.48

Inc GST
~~\$64.40~~
\$50.00

ORDER CODE:	V126
MODEL:	~
Type:	Drill Vice
Jaw Width (mm):	152
Jaw Opening (mm):	145
Jaw Depth (mm):	27
Nett Weight (kg):	7



Description

Manufactured from close grain cast iron.

Specific Features



Rear View

Product Brochure For V126

Recommended Accessories

V0532

Aluminium Magnetic Soft Jaws

V0539

Aluminium Magnetic Soft Jaws

V0536

Aluminium Magnetic Soft Jaws

V0542

Plastic Magnetic Soft Jaws

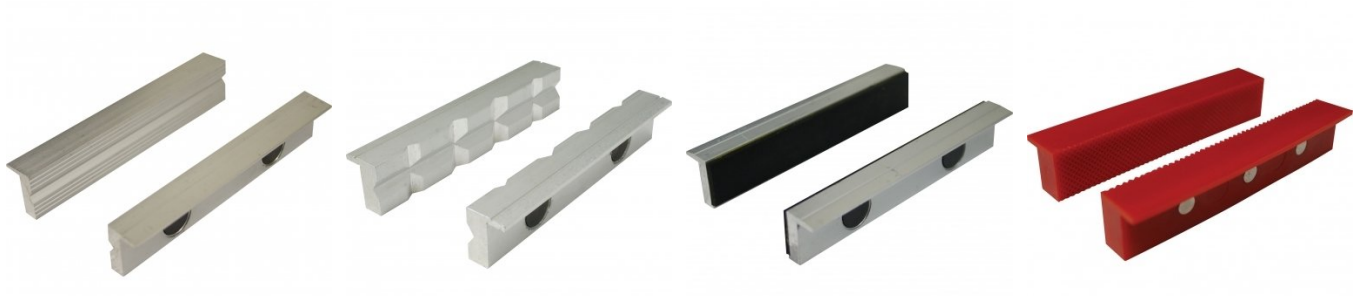

V0546

Plastic Magnetic Soft Jaws

