

Product Brochure For V1451

Drill Press Vice - TMV-130P

130mm Jaw Width
120mm Jaw Opening



On Sale

Ex GST	Inc GST
\$154.00	\$177.10
\$120.87	\$139.00

ORDER CODE:	V1451
MODEL:	TMV-130P
Type:	Precision Drill Vice
Jaw Width (mm):	130
Jaw Opening (mm):	120
Jaw Depth (mm):	35
Nett Weight (kg):	7.4



Description

Manufactured from close grain cast iron.
The Deluxe Vice comes with jaws that are hardened, with vertical and horizontal grooves for prismatic work.

Features

- 130mm wide hardened and precision ground jaws
- 120mm opening with 85mm throat
- Prismatic jaw for securely clamping round work pieces
- Compact design
- Guide screw lead in mechanism

Product Brochure For V1451

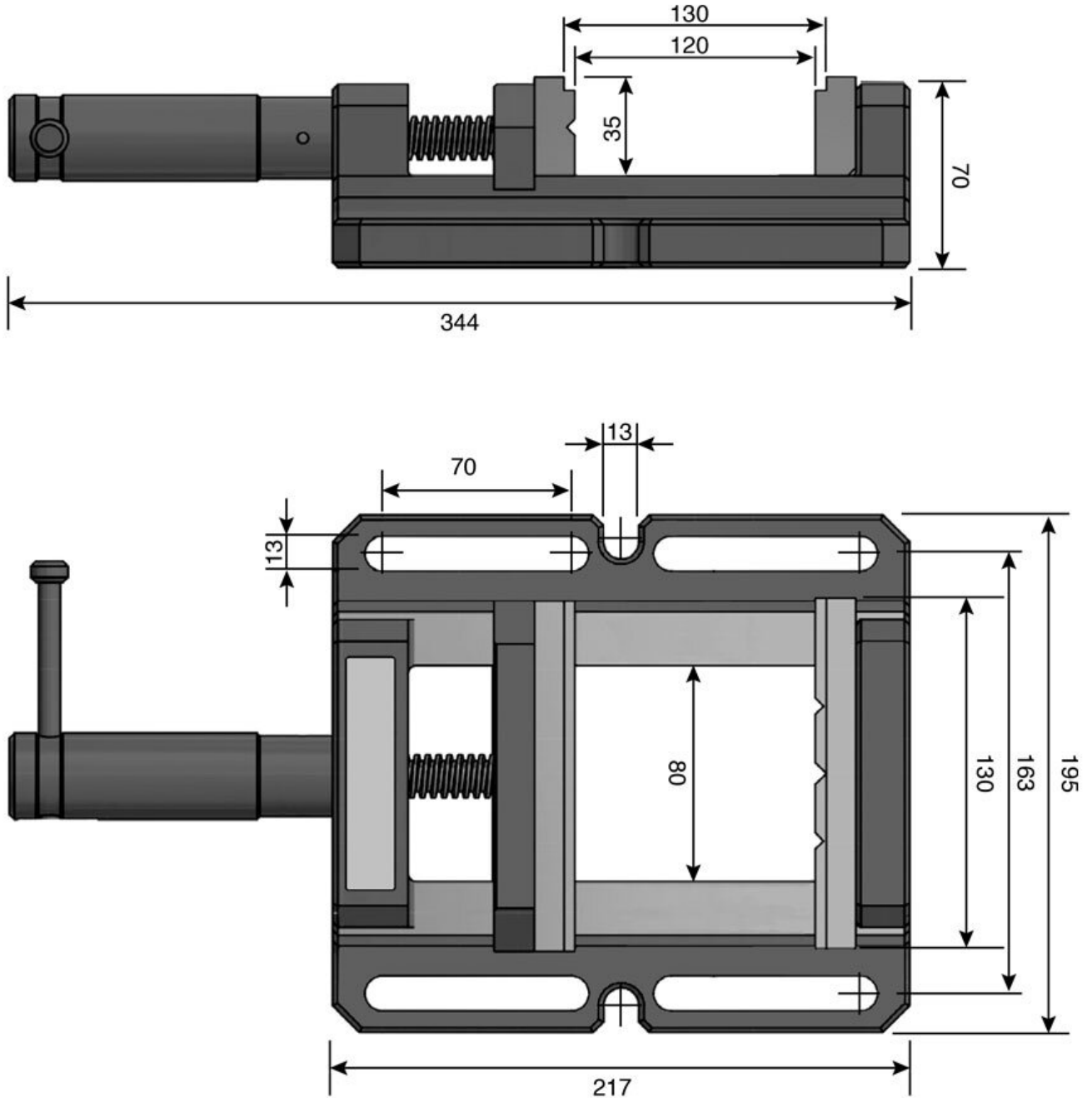

*** Dimensions are provided solely for the purpose of illustration; product tolerance may exhibit variations.**

Product Brochure For V1451

Specific Features



Rear View

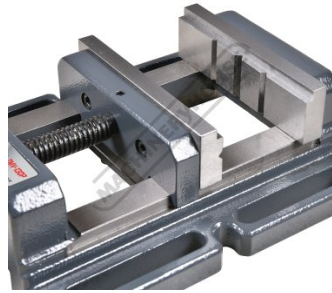

Jaws

Recommended Accessories

V053

Aluminium Magnetic Soft Jaws

V0537

Aluminium Magnetic Soft Jaws

V0534

Aluminium Magnetic Soft Jaws

V054

Plastic Magnetic Soft Jaws

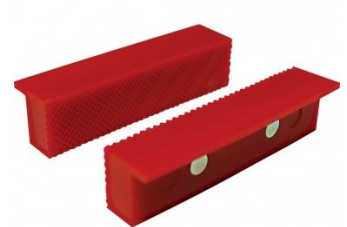

V0544

Plastic Magnetic Soft Jaws

