

Product Brochure For V1541

## Heavy Duty - Drill Press Vice - TMV-100H

100mm Jaw Width  
110mm Jaw Opening

**On Sale**

Ex GST	Inc GST
<del>\$172.00</del>	<del>\$197.80</del>
<b>\$136.52</b>	<b>\$157.00</b>



ORDER CODE:	V1541
MODEL:	TMV-100H
Type:	Heavy Duty Drill Vice
Jaw Width (mm):	100
Jaw Opening (mm):	110
Jaw Depth (mm):	35
Nett Weight (kg):	8



### Description

Heavy duty drill vice designed specifically for machine shop or tool room use. The bottom of the base is machined and slots are provided for securing to worktable.

### Features

- Heavy-duty cast iron construction
- Precision ground prismatic jaws
- Precision ground base & bed for smooth lateral movement of the jaw
- Jaw guides to prevent tilting
- 100mm jaw width
- 110mm jaw opening
- 35mm jaw height

Product Brochure For V1541

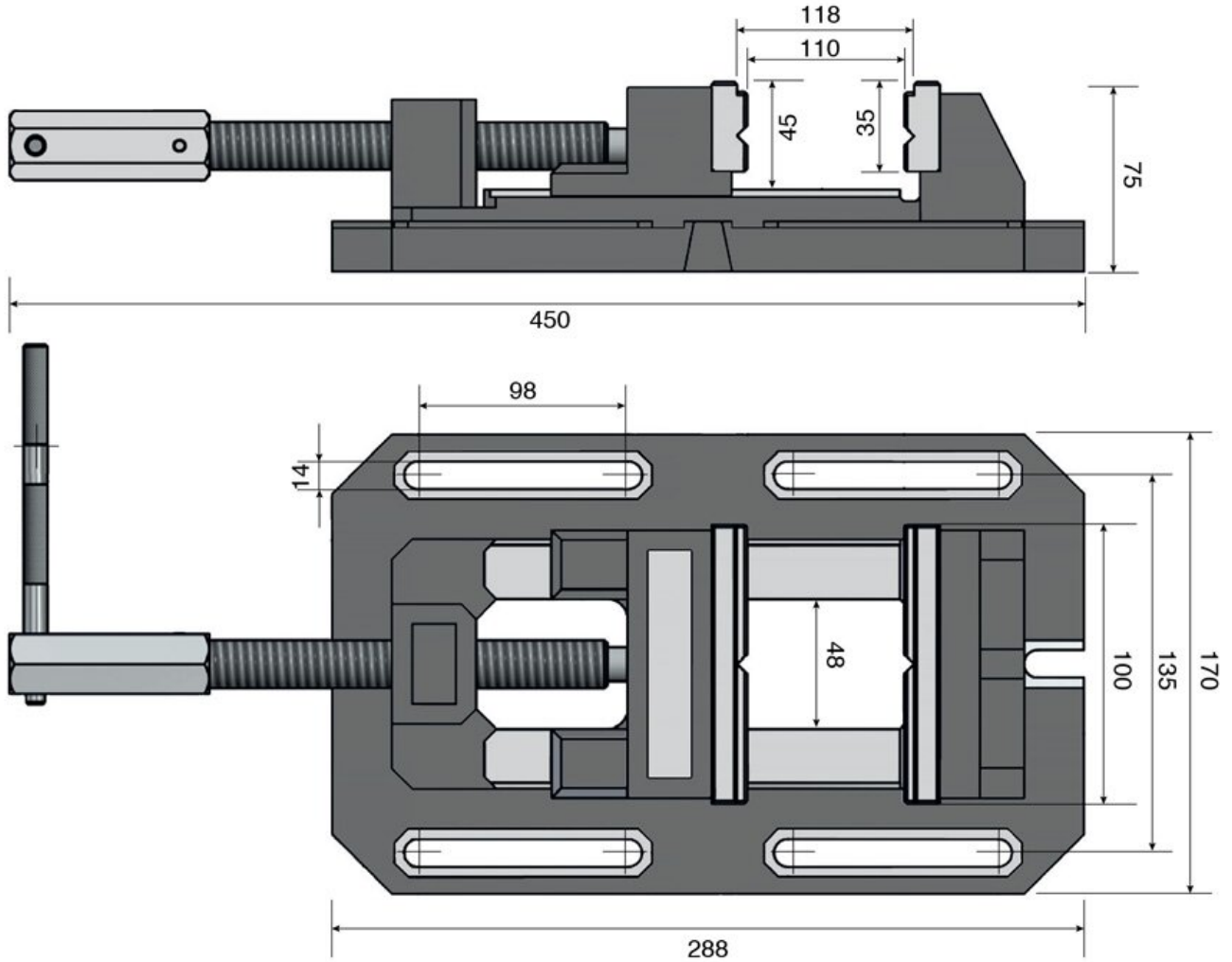

\* Dimensions are provided solely for the purpose of the illustration: product tolerance may exhibit variations.

Product Brochure For V1541

---

**Specific Features**



Rear View

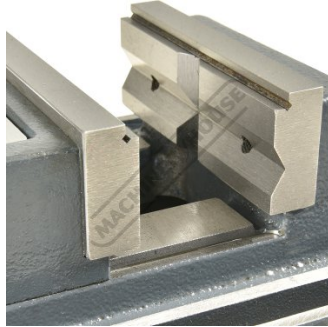

Jaws

**Recommended Accessories**

V053

Aluminium Magnetic Soft Jaws

V0537

Aluminium Magnetic Soft Jaws

V0534

Aluminium Magnetic Soft Jaws

V054

Plastic Magnetic Soft Jaws



V0544

Plastic Magnetic Soft Jaws

