

Product Brochure For W1021

Magnetic V-Pad Kit - (4 Pack) - MVDF44

2 Regular V-Pads & 2 Large V-Pads

8kg Pull Force

ORDER CODE:	W1021
MODEL:	MVDF44
Type:	Magnetic V-Pad
Size:	&
Quantity Per Pack (No.):	4
Magnet Clamp Angle (deg):	~
Pull Force (kg):	8*
Nett Weight (kg):	0.4



Description

Time saving magnetic tools for use in the shop & in the field

Light duty & tight spot holding! Build, Hold, and Position Steel

Features

- Hold and position round, flat, and square parts in light duty substructure applications!
- Each V-Pad contains 4 rare-earth magnets
- *Magnetic force is based on the longest side of Magnet with 3/8" thick steel

Includes

- 4 x Magnetic V-Pads

Product Brochure For W1021

Specific Features



Set

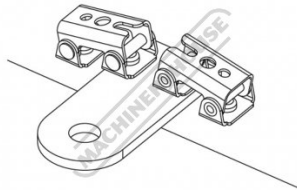

Shown In Use

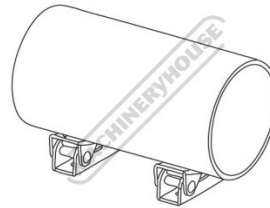

Shown In Use 2

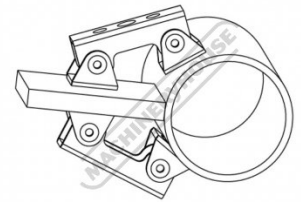

Shown In Use 3

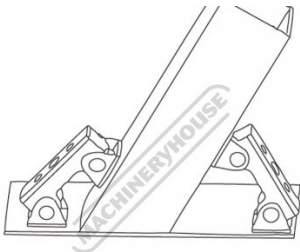

Shown In Use 4



Shown Holding 2 Pieces of Pipe



Shown Holding a Variety of Workpieces

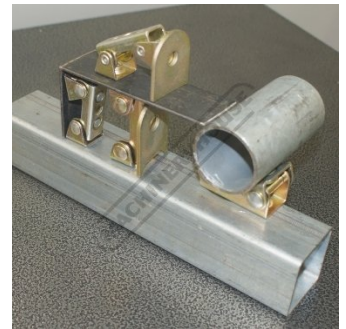

Shown holding a Variety of Workpieces 2

Recommended Accessories

W112

Micro Welding Steel Clamp Set



W113

Butt Welding Aluminium & Steel
Clamp Set



W07971

BuildPro Magspring Clamp



W1028

4 In One Utility Clamping
System

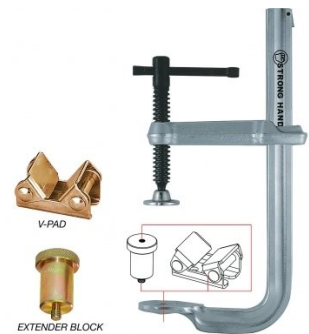

Product Brochure For W1021

W1005
Snake Magnet & Spring Clamp



W1007
Adjust-O Magnet Square - Heavy Duty



W1006
Adjust-O Magnet Square - Heavy Duty



W1011
XYZ Magnet Squares - Multi-Angle - (2-Pack)



W1015
Pipe Plier



W1014
Pipe Plier - Large

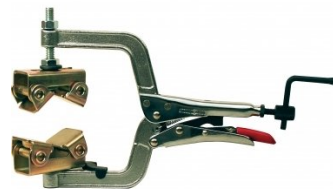

W1013
Corner Clamping Plier



W1012
Adjustable Corner Clamping Plier Set



W1018
Locking C-Clamp - Swivel Tip



W1016
Locking C-Clamp - Round Tip



W1017
Locking C-Clamp - Swivel Tip



W1010
Corner Magnets - (2-Pack)

