

Product Brochure For W1081

Multi Angle Corner Magnets - 2pc Pack - WCM-3A

45°, 90°, 135° Degrees
10kg Pull Force

On Sale

Ex GST	Inc GST
\$22.00	\$25.30
\$17.39	\$20.00



ORDER CODE:	W1081
MODEL:	WCM-3A
Type:	Corner Magnet & Multit-Angle
Size:	92 x 92 x 31mm
Quantity Per Pack (No.):	2
Magnet Clamp Angle (deg):	45°, 90° & 135°
Pull Force (kg):	10*
Nett Weight (kg):	0.4



Description

3 angle welding magnetic tools for use in the shop & in the field

Create corners by holding from the inside or outside, providing you with a unobstructed area for tack welds. One side corner "relief" provides clearance for all lips. Use the outer edges of the corner magnet for setting up materials at 45°, 90° & 135°

Features

- Powerful magnet provides an extra hand
- Multiple angle holds 45°, 90° & 135°
- 10kg Pull force
- Create 90° corners by holding from the inside or outside
- Provides unobstructed access to inside corners for perfect tack welds
- *Magnetic force is based on the longest side of Magnet with 10mm thick steel

Includes

- 2 x Inside-Outside Corner magnets

Product Brochure For W1081

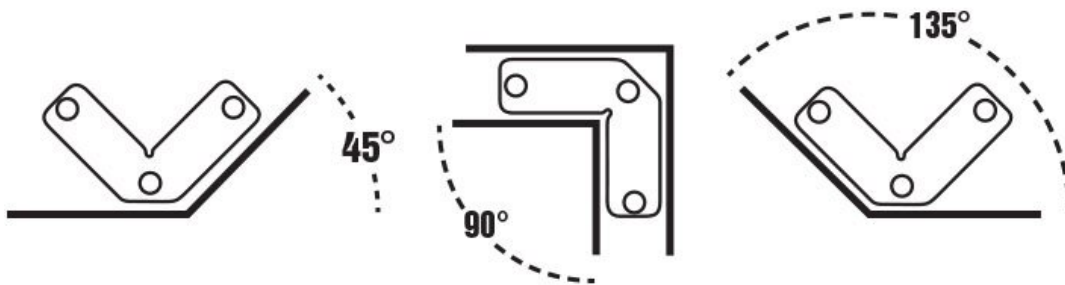
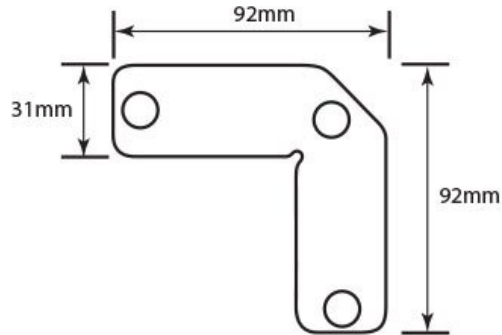

Specific Features



Multi Angle Magnets



45 Degree



90 Degree

Product Brochure For W1081

Recommended Accessories

W1082
Multi Angle Corner Magnets -
2pc Pack



W1091
Magnetic Swivel V-Pad Clamps



W1085
Switchable Multi-Angle Welding
Magnet



W1086
Switchable Multi-Angle Welding
Magnet



W1071
Switchable Multi-Angle Welding
Magnet



W1072
Switchable Multi-Angle Welding
Magnet

