

Product Brochure For W30488

15mm - Square Radius Carbide Insert

2 Piece Pack

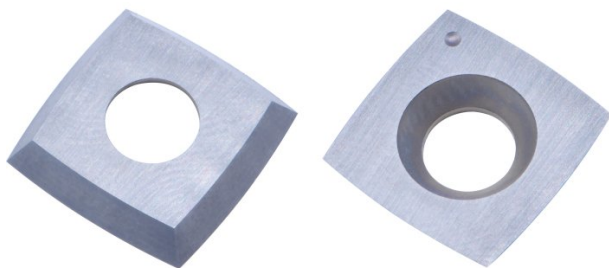

Description

Keep your carbide woodturning tools cutting cleanly with these replacement square radius tungsten carbide inserts. The square radius profile combines the versatility of a square cutter with rounded corners to help reduce catches while producing smooth, controlled cuts. Ideal for roughing, shaping, and general turning applications on bowls, spindles, and other timber projects.

Manufactured from durable tungsten carbide for extended edge life, the inserts can be rotated to expose a fresh cutting edge when worn, eliminating the need for sharpening and minimising downtime.

Features

- Replacement square radius tungsten carbide inserts
- Suits compatible carbide woodturning tools
- Ideal for roughing, shaping and general-purpose turning
- Radiused corners help reduce catches and improve surface finish
- Long-lasting tungsten carbide cutting edge
- Rotatable design provides multiple usable cutting edges
- No sharpening required
- Supplied as a convenient 2-piece pack

Includes

- 2 Piece Pack

Coming Soon

Ex GST
\$30.00

Inc GST
\$34.50

ORDER CODE:	W30488
MODEL:	~
Type:	Square Radius Carbide Insert
No. of Piece:	2
Thread Size:	~
D:	~
L (mm):	15
W (mm):	15
T (mm):	2.5
a (deg):	30°
Suits:	Wood Turning Tools - Insert Type

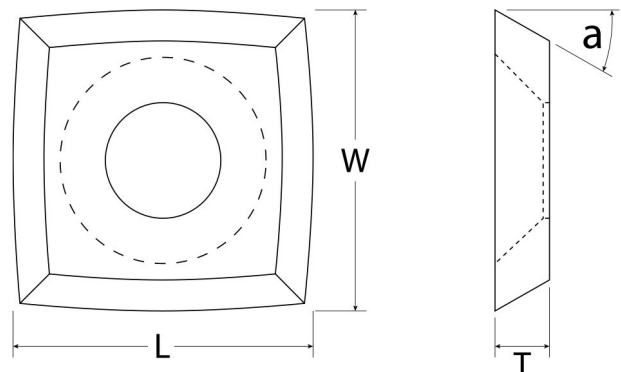

Product Brochure For W30488

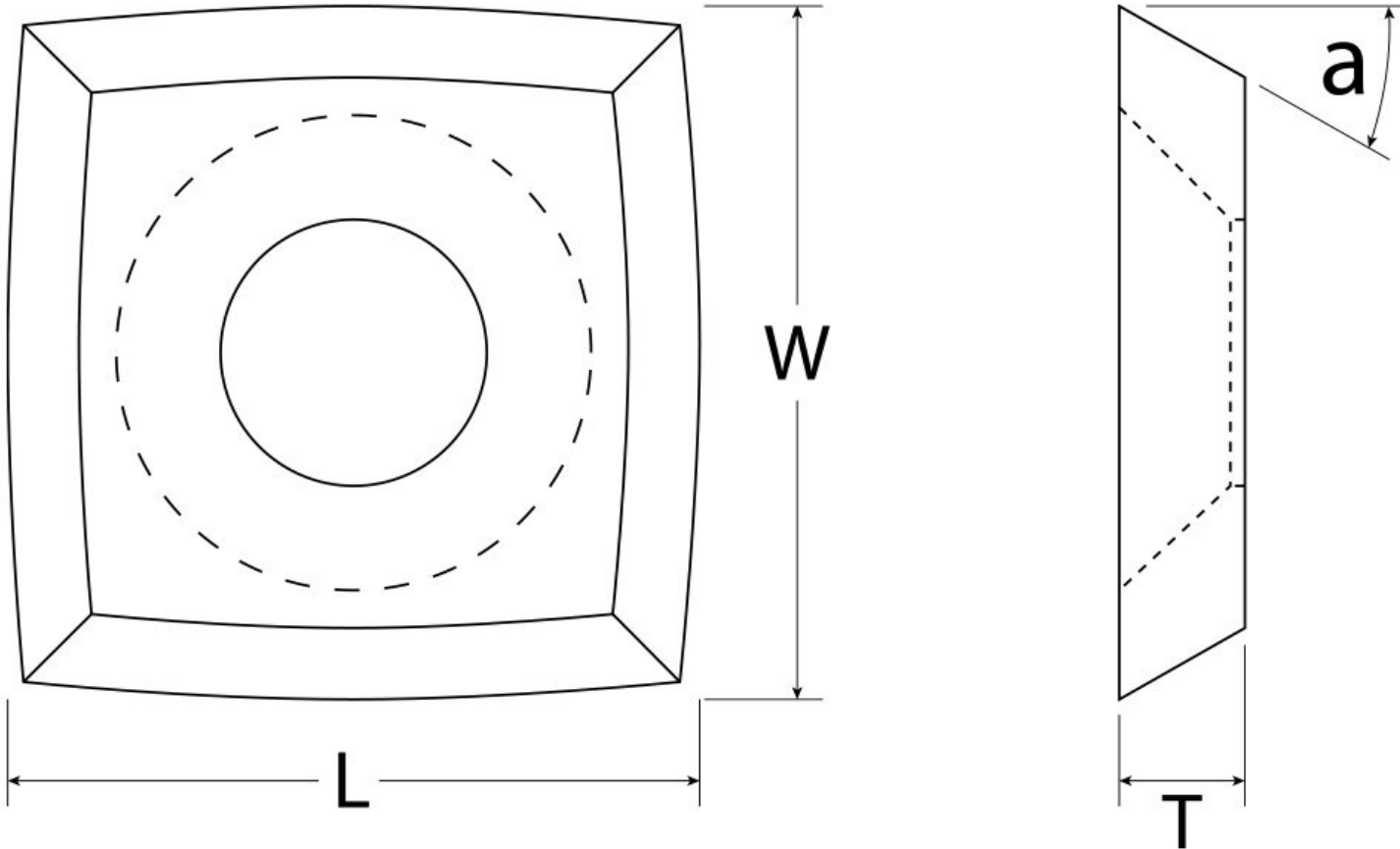

Product Brochure For W30488

Specific Features

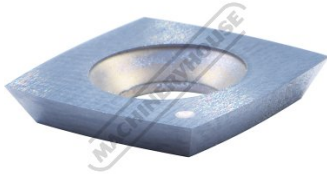

Low View

Recommended Accessories

W30495
M5 - Torx Head Screw

W3047
Wood Turning Set - 4 Piece

